

Tera technical specification



.mdd

MDD has a leading position among manufacturers of office furniture with many awards that prove quality and continuously increase demand for its products.

The realities of today's market require constant quality improvement at all levels of modern organization. This applies in particular to customer service, marketing, quality of products and also to quality of processes within the company.

Partnership relations among employees and with business partners form a base of economic growth and success of the company.

Constant investments in innovative machinery park, optimization of management systems and an expansion of production halls allow to minimize the lead times for the product of the highest quality.

More than twenty years of experience in office furniture industry come with reference from a long list of companies and institutions to show their appreciation for an efficient and comprehensive service.

MDD is highly aware of the environment.

Being located in the forest region with lake by its side, MDD takes the nature seriously and invests constantly in a modern and energy-efficient solutions to preserve the local life. Company puts emphasis on waste segregation and recycling. MDD has been awarded for the exceptional care and involvement in waste disposal. All materials used are environmentally friendly and enjoy a high 95 % rate of being recycled.



General informations:

Warranty:

MDD products - **5 years.**

Electrical components and fabric - **2 years.**

Certificate - MFC:



Boards density:

12 mm - 690 - 750 kg/m³

18 mm - 650 - 690 kg/m³

28 mm - 610 - 630 kg/m³

36 mm - 610 - 630 kg/m³

Assembly:

product delivered in separate elements

Packing:

cartboard, perforated plastic mesh wrap,

bubble wrap

Technical specification

1. **Worktop** - MFC 28 mm, ABS edge
2. **Low side panel** - MFC 28 mm, ABS edge
3. **Top element** - top MFC 28 mm + Glass LACOBEL 4 mm, front MFC 18 mm, coated with HPL gloss
4. **High side panel** - MFC 28 mm, ABS edge
5. **Front** - MFC 18 mm, ABS edge
6. **Decorative stripe** - PVC, colour: M009 - aluminum semi-matt
7. **Corner unit** - melamine board covered with HPL - gloss
8. **Side panel linking low and high fronts** - MFC 28 mm, ABS edge
9. **Frame to optional top element with lightening** - metal powder-coated, white colour
10. **Light switch**
11. **LED illumination** - cold white color (verging on the blue shade)
12. **Cable grommets** - Ø80 mm
13. **Supporting leg NL41** - required for connecting the tops

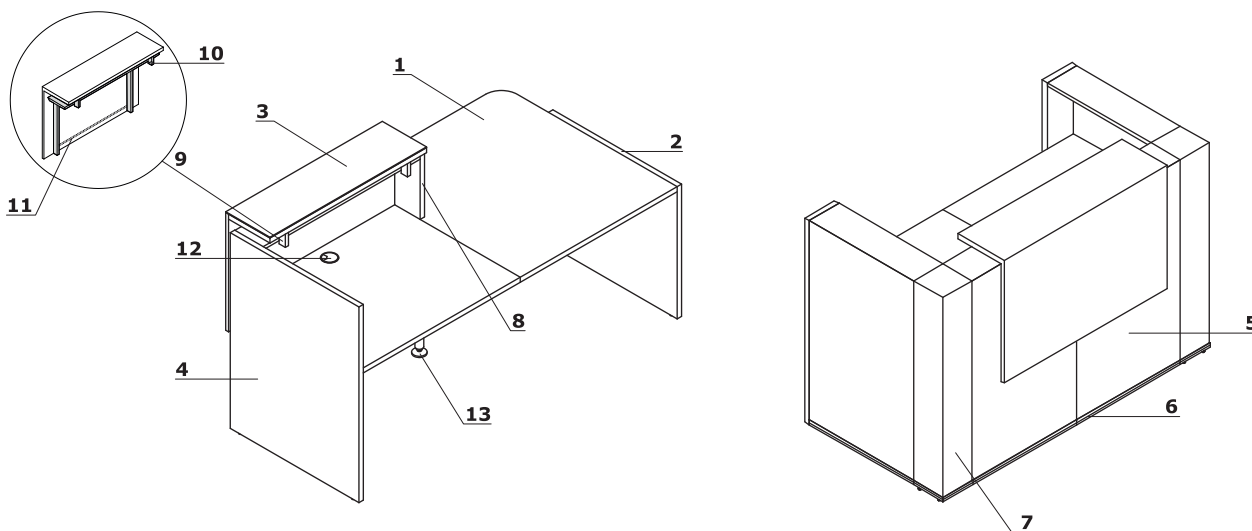

www.mdd.eu

Ending elements application

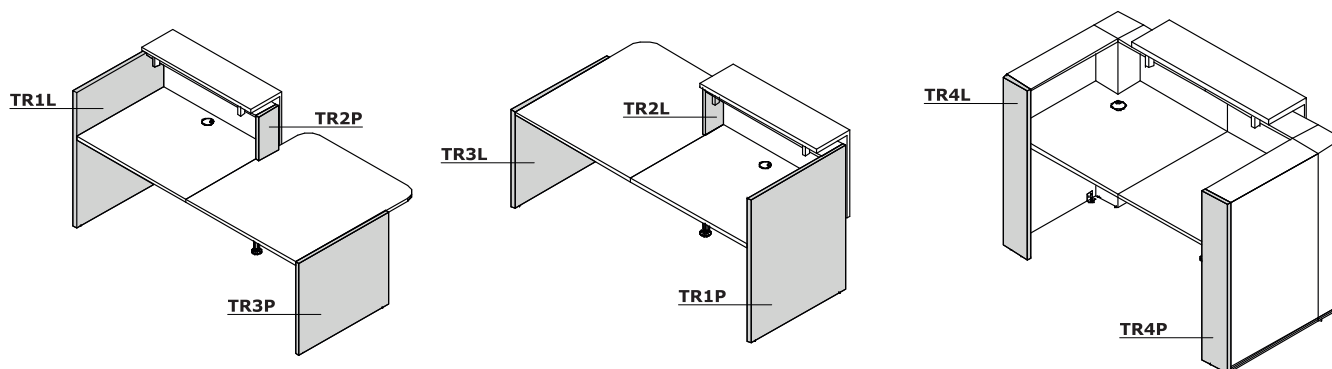

Tera	Date of preparation 21.09.2020	The data contained in this document is valid in the day of its preparation. Change of the product, as long as it does not affect the basic features of it, does not require consistent updates of the document.	page 3/7 technical specification
------	-----------------------------------	---	-------------------------------------

Dimensions

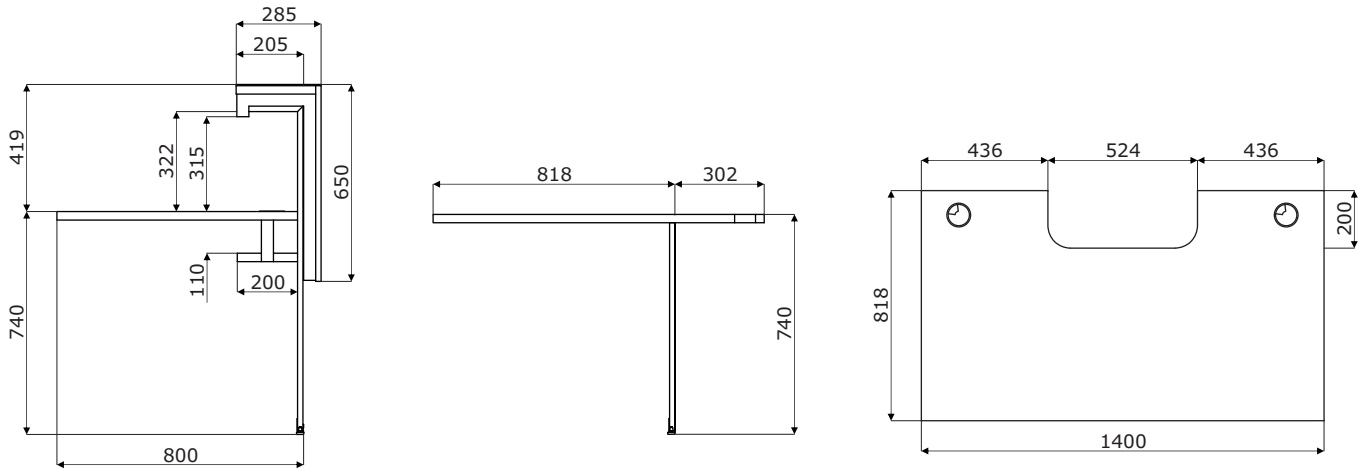

Composition elements *

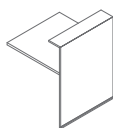
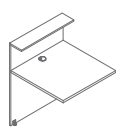

TR08
800 / 818 / 1090
25 kg

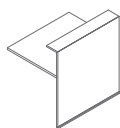
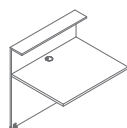

TR10
1000 / 818 / 1090
32 kg

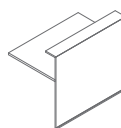
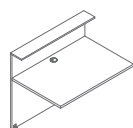

TR12
1200 / 818 / 1090
36 kg

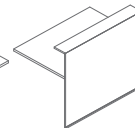
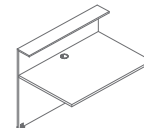

TR14
1400 / 818 / 1090
38 kg

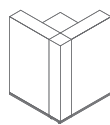
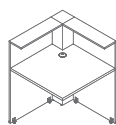

TR90
818 / 818 / 1090
36 kg

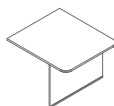
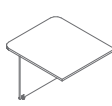

TR11
1000 / 1120 / 740
30 kg

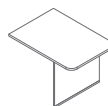
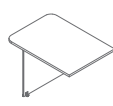

TR18
800 / 1120 / 740
24 kg



TR99
1000 / 282 / 650
17 kg

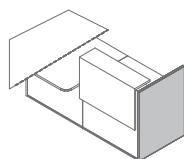

TR1L
28 / 820 / 1090
17 kg

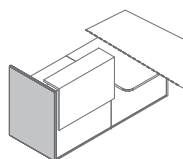

TR1P
28 / 820 / 1090
17 kg

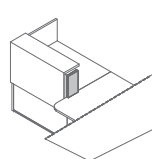

TR2L
28 / 182 / 350
1,5 kg

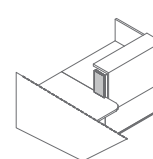

TR2P
28 / 182 / 350
1,5 kg

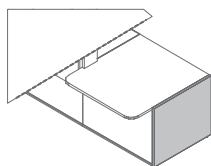

TR3L
28 / 820 / 740
12 kg

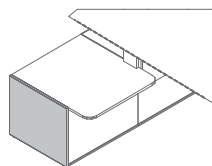

TR3P
28 / 820 / 740
12 kg

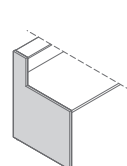

TR5L
28 / 820 / 1090
13,5 kg

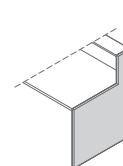

TR5P
28 / 820 / 1090
13,5 kg

* dimensions expressed in millimeters: width x depth x height

Composition elements *

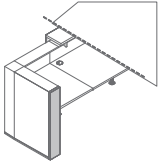

TR4L
28 / 182 / 1090
4 kg

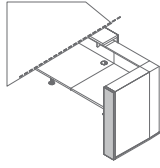

TR4P
28 / 182 / 1090
4 kg



NL41
585 / 142 / 712
2 kg

Sneeze guard *

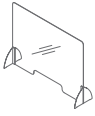

NPX1
1000 / 250 / 750
3 kg

* dimensions expressed in millimeters: width x depth x height

Tera	Date of preparation 21.09.2020	The data contained in this document is valid in the day of its preparation. Change of the product, as long as it does not affect the basic features of it, does not require consistent updates of the document.	page 6/7
			products

Upper top, worktop, body, front, ending elements

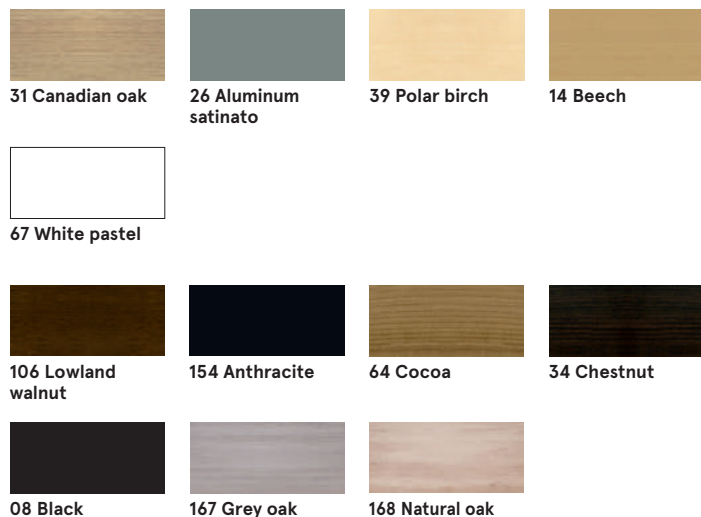

Supporting leg

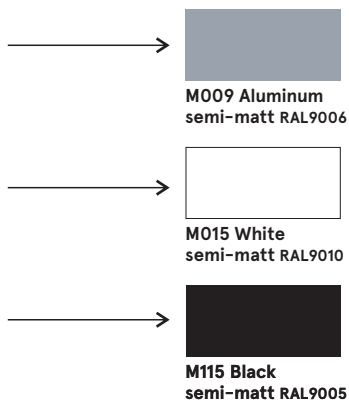

Corner unit, top - HPL

