

EDAN Agile PLM Electronic Signature Information

--Signatures related to this document and performed in EDAN Agile PLM.

文件名称(Document Name) : SE-1说明书_英文

文件编号(Number) : 01.54.019929

版本(Version) : 1.6

产品型号(Product Model) : SE-1

项目编码(Project Code) : 2080C000

签批信息(Signature):

作者(Originator) : 肖 丽军 (xiaolijun) 2016-10-20 15:31:58

审核人(Reviewers) : 董 宁 (dongning) 2016-10-20 15:53:43

审核人(Reviewers) : 肖 玉华 (xiaoyuhua) 2016-10-20 16:30:19

批准人(Approvers) : 王 力维 (wangliwei) 2016-10-24 10:36:04

批准人(Approvers) : 杨 洁 (yangjie) 2016-10-24 11:04:30

批准人(Approvers) : 陈 浩杰 (chenhaojie) 2016-10-24 09:21:25

SE-1

Electrocardiograph

Version 1.6

User Manual

CE₀₁₂₃

EDAN

About this Manual

P/N: 01.54.019929

MPN: 01.54.019929016

Release Date: Oct. 2016

© Copyright EDAN INSTRUMENTS, INC. 2005-2016. All rights reserved.

Statement

This manual will help you understand the operation and maintenance of the product better. It is reminded that the product shall be used strictly complying with this manual. User's operation failing to comply with this manual may result in malfunction or accident for which EDAN INSTRUMENTS, INC. (hereinafter called EDAN) can not be held liable.

EDAN owns the copyrights of this manual. Without prior written consent of EDAN, any materials contained in this manual shall not be photocopied, reproduced or translated into other languages.

Materials protected by the copyright law, including but not limited to confidential information such as technical information and patent information are contained in this manual, the user shall not disclose such information to any irrelevant third party.

The user shall understand that nothing in this manual grants him, expressly or implicitly, any right or license to use any of the intellectual properties of EDAN.

EDAN holds the rights to modify, update, and ultimately explain this manual.

Responsibility of the Manufacturer

EDAN only considers itself responsible for any effect on safety, reliability and performance of the equipment if:

Assembly operations, extensions, re-adjustments, modifications or repairs are carried out by persons authorized by EDAN, and

The electrical installation of the relevant room complies with national standards, and

The instrument is used in accordance with the instructions for use.

Terms Used in this Manual

This guide is designed to give key concepts on safety precautions.

WARNING

A **WARNING** label advises against certain actions or situations that could result in personal injury or death.

CAUTION

A **CAUTION** label advises against actions or situations that could damage equipment, produce inaccurate data, or invalidate a procedure.

NOTE

A **NOTE** provides useful information regarding a function or a procedure.

Table of Contents

Chapter 1 Safety Guidance	1
1.1 Indications for Use/Intended Use.....	1
1.2 Warnings and Cautions.....	1
1.2.1 Safety Warnings	1
1.2.2 Lithium Battery Care Warnings	5
1.2.3 General Cautions.....	6
1.2.4 Cleaning & Disinfection Cautions	7
1.3 List of Symbols	7
Chapter 2 Introduction.....	10
2.1 Top Panel.....	10
2.2 Key Panel and Keys	11
2.3 Patient Cable Socket and Signal Interface	14
2.4 Mains Connection and Switch	16
2.5 Bottom Panel.....	17
2.6 Function Features	18
Chapter 3 About SE-1 Application Interface.....	19
3.1 About the Main Interface	19
3.2 About the System Setup Interface	20
Chapter 4 Operation Preparations	21
4.1 Power and Earthing.....	21
4.2 Loading/Replacing Recorder Paper	22
4.3 Preparing the Patient	23
4.3.1 Instructing the Patient	23
4.3.2 Preparing the Skin.....	23
4.4 Connecting the Patient Cable to the Electrocardiograph and Electrodes.....	24
4.5 Attaching Electrodes to the Patient	25
4.6 Inspection Before Power-On.....	28
Chapter 5 Switching On the Electrocardiograph.....	30
Chapter 6 Entering Patient Information	31
Chapter 7 Printing ECG Reports	32
7.1 Auto Mode.....	32
7.2 Manual Mode	33

7.3 ECG Report.....	34
Chapter 8 Settings	35
8.1 Filter Settings	36
8.2 Recording Settings	36
8.3 Date and Time Settings	37
8.4 Print Head Test.....	37
8.5 External Input/Output Settings.....	38
8.6 Key Beep and QRS Beep Settings	38
8.7 Rhythm Lead Settings.....	38
Chapter 9 Switching Off the Electrocardiograph	39
Chapter 10 Hint Information	40
Chapter 11 Cleaning, Care and Maintenance	41
11.1 General Points	41
11.2 Cleaning	41
11.2.1 Cleaning the Main Unit.....	42
11.2.2 Cleaning the Patient Cable.....	42
11.2.3 Cleaning the Reusable Electrodes.....	42
11.3 Disinfection.....	43
11.3.1 Disinfecting the Main Unit.....	43
11.3.2 Disinfecting the Patient Cable.....	44
11.3.3 Disinfecting the Reusable Electrodes.....	44
11.4 Care and Maintenance.....	44
11.4.1 Recharge and Replacement of Battery.....	44
11.4.2 Recorder Paper.....	45
11.4.3 Maintenance of Main Unit, Patient Cable and Electrodes	46
Chapter 12 Accessories and Ordering Information	49
Chapter 13 Warranty and Service	51
13.1 Warranty	51
13.2 Contact information	51
Appendix 1 Technical Specifications	52
A1.1 Safety Specifications	52
A1.2 Environment Specifications	53
A1.3 Physical Specifications.....	53
A1.4 Power Supply Specifications.....	53
A1.5 Performance Specifications.....	54

Appendix 2 EMC Information..... 56
Appendix 3 Abbreviation..... 60

Chapter 1 Safety Guidance

This chapter provides important safety information related to the use of the single channel electrocardiograph.

1.1 Indications for Use/Intended Use

The intended use of the single channel electrocardiograph is to acquire ECG signals from adult and pediatric patients through body surface ECG electrodes. The electrocardiograph is intended to be used only in hospitals or healthcare facilities by doctors and trained healthcare professionals. The cardiogram recorded by the single channel electrocardiograph can help users to analyze and diagnose heart disease. However the ECG is offered to clinicians on an advisory basis only.

1.2 Warnings and Cautions

In order to use the electrocardiograph safely and effectively, and avoid possible dangers caused by improper operation, please read through the user manual and be sure to be familiar with all functions of the equipment and proper operation procedures before use.

Please pay more attention to the following warning and caution information.

Note:

1. This device is not intended for home use.
2. The pictures and interfaces in this manual are for reference only.

1.2.1 Safety Warnings

WARNING

1. The electrocardiograph is intended to be used by qualified physicians or personnel professionally trained. They should be familiar with the contents of this user manual before operation.
 2. Only qualified service engineers can install this equipment, and only service engineers authorized by the manufacturer can open the shell. Otherwise, safety hazards may happen.
 3. Only qualified installation or service engineers can shift the mains supply shift switch (100V-115V~/220V-240V~) according to local mains supply specifications.
-

WARNING

4. The results given by the equipment should be examined based on the overall clinical condition of the patient, and they can not substitute for regular checking.
 5. This device is not intended for treatment.
 6. **EXPLOSION HAZARD** - Do not use the electrocardiograph in the presence of flammable anesthetic mixtures with oxygen or other flammable agents.
 7. **SHOCK HAZARD** - The power receptacle must be a hospital grade grounded outlet. Never try to adapt the three-prong plug to fit a two-slot outlet.
 8. If the integrity of the external protective conductor is in doubt, the equipment should be powered by a built-in rechargeable battery.
 9. Do not use this equipment in the presence of high static electricity or high voltage equipment which may generate sparks.
 10. This equipment is not designed for direct cardiac application.
 11. Only the patient cable and other accessories supplied by the manufacturer can be used. Or else, the performance and electric shock protection cannot be guaranteed.
 12. The use of patient cable and other accessories not supplied by the manufacturer may result in increased emissions or decreased immunity of the equipment.
 13. Make sure that all electrodes are connected to the patient correctly before operation.
 14. Ensure that the conductive parts of electrodes and associated connectors, including neutral electrodes, do not come in contact with earth or any other conducting objects.
 15. Electrodes with defibrillator protection should be used while defibrillating. To avoid a polarization or DC offset voltage, use non-polarizing electrodes (which will not form a DC offset voltage when subjected to a DC current) such as silver/silver-chloride types if there is a situation where there is a likelihood that a defibrillation procedure will be necessary.
 16. There is no danger for patients to use pacemakers. However, if a pacemaker is used, the results given by the equipment may be invalid, or lose the clinical significance.
 17. Do not touch the patient, bed, table or the equipment while using the ECG together with a defibrillator.
 18. Do not touch accessible parts of electrical equipment and the patient simultaneously.
 19. In order to avoid being burnt, please keep the electrodes far away from the radio knife while using electrosurgical equipment.
-
-

WARNING

20. Disposable electrodes must be used during defibrillation
21. Accessory equipment connected to the analog and digital interfaces must be certified according to the respective IEC/EN standards (e.g. IEC/EN 60950 for data processing equipment and IEC/EN 60601-1 for medical equipment). Furthermore all configuration shall comply with the valid version of the standard IEC/EN 60601-1-1. Therefore anybody, who connects additional equipment to the signal input or output connector to configure a medical system, must make sure that it complies with the requirements of the valid version of the system standard IEC/EN 60601-1-1. If in doubt, consult our technical service department or your local distributor.
22. Connecting any accessory (such as external printer) or other device (such as the computer) to this electrocardiograph makes a medical system. In that case, additional safety measures should be taken during installation of the system, and the system shall provide:
- a) Within the patient environment, a level of safety comparable to that provided by medical electrical equipment complying with IEC/EN 60601-1, and
 - b) Outside the patient environment, the level of safety appropriate for non-medical electrical equipment complying with other IEC or ISO safety standards.
23. All the accessories connected to system must be installed outside the patient vicinity, if they do not meet the requirement of IEC/EN 60601-1.
24. **SHOCK HAZARD** - Don't connect non-medical electrical equipment, which has been supplied as a part of the system, directly to the wall outlet when the non-medical equipment is intended to be supplied by a multiple portable socket-outlet with an isolation transformer.
25. **SHOCK HAZARD** - Don't connect electrical equipment, which has not been supplied as a part of the system, to the multiple portable socket-outlet supplying the system.
26. Do not connect any equipment or accessories that are not approved by the manufacturer or that are not IEC/EN 60601-1 approved to the electrocardiograph. The operation or use of non-approved equipment or accessories with the electrocardiograph is not tested or supported, and electrocardiograph operation and safety are not guaranteed.
-
-

WARNING

27. Do not use the additional multiple portable socket-outlet or extension cord in the medical electrical system, unless it's specified as part of the system by manufacturer. And the multiple portable socket-outlets provided with the system shall only be used for supplying power to equipment which is intended to form part of the system.
28. The summation of leakage current should never exceed leakage current limits while several other units are used at the same time.
29. The potential equalization conductor can be connected to that of other equipment when necessary, to make sure that all these devices are connected to the potential equalization bus bar of the electrical installation.
30. The EQUIPMENT is protected against malfunctions caused by electrosurgery according to the clause 36.202.101 in the standard IEC 60601-2-25.
31. The electrocardiograph shall not be serviced or maintained while in use with a patient.
32. The appliance coupler or mains plug is used as isolation means from supply mains. Position the electrocardiograph in a location where the operator can easily access the disconnection device.
33. The medical electrical equipment needs to be installed and put into service according to Appendix 2 EMC information.
34. The equipment should not be used adjacent to or stacked with other equipment, refer to the recommended separation distances provided in Appendix 2 EMC Information.
35. Portable and mobile RF communications equipment can affect medical electrical equipment, refer to the recommended separation distances provided in Appendix 2 EMC Information.
36. Assembly of the electrocardiograph and modifications during actual service life shall be evaluated based on the requirements of IEC60601-1.
-
-

1.2.2 Lithium Battery Care Warnings

WARNING

1. Improper operation may cause the lithium battery (hereinafter called battery) to be hot, ignited or exploded, and it may lead to the decrease of the battery capacity. It is necessary to read the user manual carefully and pay more attention to warning messages.
 2. Only qualified service engineers authorized by the manufacturer can open the battery compartment and replace the battery, and batteries of the same model and specification should be used.
 3. Danger of explosion -- Do not reverse the anode and the cathode when installing the battery.
 4. Do not heat or splash the battery or throw it into fire or water.
 5. When leakage or foul smell is found, stop using the battery immediately. If your skin or cloth comes into contact with the leakage liquid, cleanse it with clean water at once. If the leakage liquid splashes into your eyes, do not wipe them. Irrigate them with clean water first and go to see a doctor immediately.
 6. The device and accessories are to be disposed of according to local regulations after their useful lives. Alternatively, they can be returned to the dealer or the manufacturer for recycling or proper disposal. Batteries are hazardous waste. Do NOT dispose of them together with house-hold garbage. At the end of their lives hand the batteries over to the applicable collection points for the recycling of waste batteries. For more detailed information about recycling of this product or the battery, please contact your local Civic Office, or the shop where you purchased the product.
 7. Only when the device is off can the battery be installed or removed.
 8. Remove the battery from the electrocardiograph when the electrocardiograph is not used for a long time.
 9. If the battery is stored alone and not used for a long time, we recommend that the battery should be charged at least once every 6 months to prevent overdischarge.
-

1.2.3 General Cautions

CAUTION

1. Avoid liquid splash and excessive temperature. The temperature must be kept between 5 °C and 40 °C during operation, and it should be kept between -20 °C and 55 °C during transportation and storage.
2. Do not use the equipment in a dusty environment with bad ventilation or in the presence of corrosive.
3. Make sure that there is no intense electromagnetic interference source around the equipment, such as radio transmitters or mobile phones etc. Attention: large medical electrical equipment such as electrosurgical equipment, radiological equipment and magnetic resonance imaging equipment etc. is likely to bring electromagnetic interference.
4. Before use, the equipment, patient cable and electrodes etc. should be checked. Replacement should be taken if there is any evident defectiveness or aging symptom which may impair the safety or the performance.
5. The following safety checks should be performed at least every 24 months by a qualified person who has adequate training, knowledge, and practical experience to perform these tests.
 - a) Inspect the equipment and accessories for mechanical and functional damage.
 - b) Inspect the safety relevant labels for legibility.
 - c) Inspect the fuse to verify compliance with the rated current and circuit-breaking characteristics.
 - d) Verify that the device functions properly as described in the instructions for use.
 - e) Test the protection earth resistance according to IEC/EN 60601-1: Limit 0.1 ohm.
 - f) Test the earth leakage current according to IEC/EN 60601-1: Limit: NC 500µA, SFC 1000µA.
 - g) Test the enclosure leakage current according to IEC/EN 60601-1: Limit: NC 100µA, SFC 500µA.
 - h) Test the patient leakage current according to IEC/EN 60601-1: Limit: NC a.c. 10µA, d.c. 10µA; SFC a.c. 50µA, d.c. 50µA.
 - i) Test the patient auxiliary current according to IEC/EN 60601-1: Limit: NC a.c. 10µA, d.c. 10µA; SFC a.c. 50µA, d.c. 50µA.

CAUTION

- j) Test the patient leakage current under single fault condition with mains voltage on the applied part according to IEC/EN 60601-1: Limit: 50 μ A (CF)



The data should be recorded in an equipment log. If the device is not functioning properly or fails any of the above tests, the device has to be repaired.













6. Ruptured fuse must only be replaced with that of the same type and rating as the original.







1.2.4 Cleaning & Disinfection Cautions**CAUTION**

1. Turn off the power before cleaning and disinfection. If the mains supply is used, the power cord should be dragged out of the outlet. Prevent the detergent from seeping into the equipment.
2. Do not immerse the unit or the patient cable into liquid under any circumstances.
3. Do not clean the unit and accessories with abrasive fabric and avoid scratching the electrodes.
4. Any remainder of detergent should be removed from the unit and the patient cable after cleaning.
5. Do not use chloric disinfectant such as chloride, sodium hypochlorite etc.

1.3 List of Symbols

No.	Symbol	Description
1		Output
2		Input

3		DEFIBRILLATION-PROOF TYPE CF APPLIED PART
4		Attention, consult ACCOMPANYING DOCUMENTS
5		Operating instructions
6		Equipotential grounding
7		Alternating Current
8		"ON" (power)
9		"OFF" (power)
10		Battery check
11		Battery recharging indicator
12		General symbol for recovery/recyclable
13	P/N	Part Number
14		SERIAL NUMBER
15		Date of manufacture

16		MANUFACTURER
17		AUTHORISED REPRESENTATIVE IN THE EUROPEAN COMMUNITY
18		CE marking
19		Disposal method
20		Refer to User Manual (Background: Blue; Symbol: White)
21		Warning (Background: Yellow; Symbol&Outline: Black)
22	Rx Only	Caution: Federal (U.S.) law restricts this device to sale by or on the order of a physician.

NOTE: The user manual is printed in black and white.

Chapter 2 Introduction

SE-1 electrocardiograph is a high-performance single channel digital electrocardiograph.

1-channel ECG wave and the real-time heart rate can be viewed on the LCD screen, and printed out by using a high resolution thermal recorder. The auto and manual modes can be chosen freely. SE-1 can be powered by the mains supply or a built-in rechargeable lithium battery.

Configuration: main unit and accessories, including patient cable, chest electrodes, limb electrodes, thermal recorder paper, power cord etc.

WARNING

1. This equipment is intended for use on adult and pediatric patients only.
2. This equipment is not designed for direct cardiac application.
3. The results given by the equipment should be examined based on the overall clinical condition of the patient, and they can not substitute for regular checking.

2.1 Top Panel



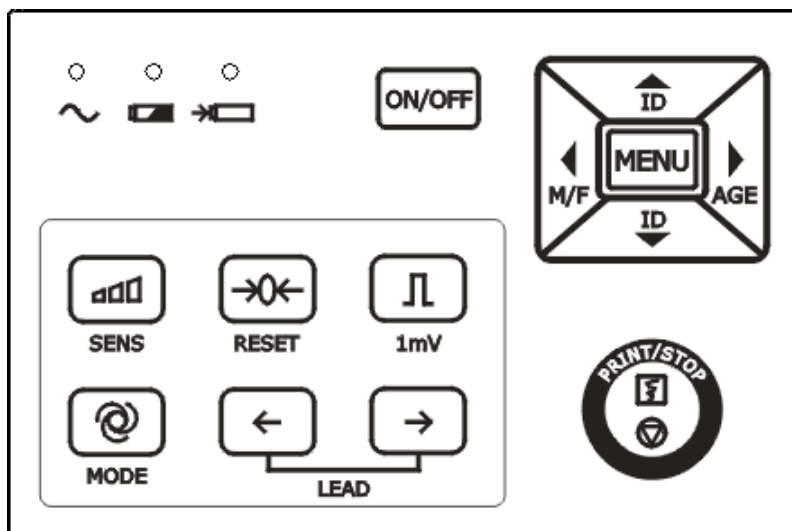

Figure 2-1 Main Unit

2.2 Key Panel and Keys



1) Indicator

	Mains supply indicator: when the device is powered by the mains supply, the indicator will be lit.
	Battery indicator: when the device is powered by a built-in rechargeable lithium battery, the indicator will be lit.
	Battery recharging indicator: after you connect the power cord to the outlet and press the mains switch, both the battery recharging indicator and the mains supply indicator will be lit.

Note: When the device is powered off, the recharging indicator is still lit after the battery is fully charged.

2) SENS (Sensitivity Switch Key)



The sensitivity switch order: $\times 1 \rightarrow \times 2 \rightarrow \text{AGC} \rightarrow \cdot 25 \rightarrow \cdot 5$.

The measurable and recordable ECG signal range varies with the sensitivity, as the following list shows.

Option	Sensitivity	Signal Range
$\times 1$	10mm/mV	-2.5mV ~ +2.5mV
$\times 2$	20mm/mV	-1.25mV ~ +1.25mV
AGC	Adjust sensitivity automatically	Vary with the adjusted sensitivity

· 25	2.5mm/mV	-10mV ~ +10mV
· 5	5mm/mV	-5mV ~ +5mV

If the fluctuating range of the ECG signal is great, it's better to choose **AGC** because the sensitivity can be adjusted automatically in this mode.

Note: This key is ineffective during the printing course in the auto mode.

3) RESET (Lead Locking Key)



In the manual mode, during the printing course, pressing this key can lock the lead, and then the corresponding ECG wave shows a straight line. The lead will be unlocked automatically after 1 second. So in the case of baseline drift, press this key to draw the baseline to zero quickly, and the ECG wave resumes after 1 second.

4) 1mV Calibration Key



In the manual mode, press this key to print a 1mV calibration mark during the printing course.

5) MODE (Mode Switch Key)



Press this key to select a working mode among four auto modes and a manual mode. The switch order of leads in each mode is listed in Table 2-1.

Table 2-1 Lead Switch Order in Different Modes

Mode	Switch Order (from Left to Right)											
MANU	I	II	III	aVR	aVL	aVF	V1	V2	V3	V4	V5	V6
AUTO1	I	II	III	aVR	aVL	aVF	V1	V2	V3	V4	V5	V6
AUTO2	aVL	I	aVR	II	aVF	III	V1	V2	V3	V4	V5	V6
AUTO3	I	aVR	V1	V4	II	aVL	V2	V5	III	aVF	V3	V6
AUTO4	2-channel auto mode (AUTO1 + Rhythm Lead)											

6) LEAD (Lead Switch Key)

In the manual mode, press this key to switch the leads in order.

7) PRINT/STOP Key

Press this key to begin or stop printing ECG reports.

8) ON/OFF Key

After you connect the power cord to the outlet and press the mains switch, press this key to turn on or off the device.

9) MENU Key

Press this key to open the system setup interface.

10) ID Setting Key

Press these two keys to set the patient ID. Press the up arrow key to increase the ID number and press the down arrow key to decrease the ID number.

11) M/F

Press the **M/F** key to set the sex of the patient to **Male** or **Female**.

12) AGE



Press the **AGE** key to set the patient's age group to **CHILD**, **ADULT** or **OLD**.

2.3 Patient Cable Socket and Signal Interface

As Figure 2-1 shows, on the right side of the main unit are the patient cable socket, RS232 socket (reserved), external input/output socket and USB interface (reserved).

1) Patient Cable Socket

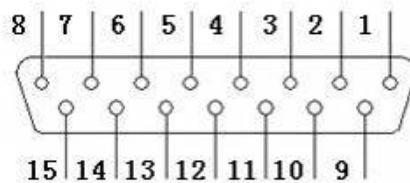

: DEFIBRILLATION-PROOF TYPE CF APPLIED PART

: Attention, consult ACCOMPANYING DOCUMENTS

Definitions of corresponding pins:

Pin	Signal	Pin	Signal	Pin	Signal
1	C2 / V2	6	SH	11	F / LL
2	C3 / V3	7	NC	12	C1 / V1 or NC
3	C4 / V4	8	NC	13	C1 / V1
4	C5 / V5	9	R / RA	14	RF (N) / RL or NC
5	C6 / V6	10	L / LA	15	RF (N) / RL

Note: The left side of “/” is European standard; and the right side is American standard.

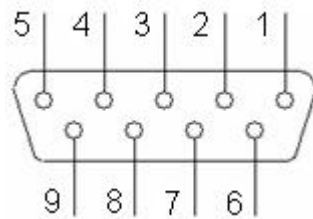
2) RS232 Socket (Reserved)

Definitions of corresponding pins:

Pin	Signal	Pin	Signal	Pin	Signal
1	NC	4	NC	7	NC
2	RxD (input)	5	GND	8	NC
3	TxD (output)	6	NC	9	NC

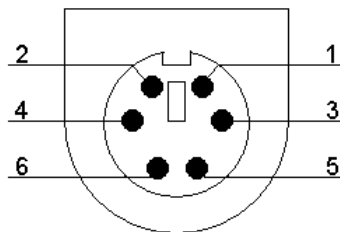
3) External Input/Output Socket

Definitions of corresponding pins:

Pin	Signal	Pin	Signal
1	GND	4	GND
2	GND	5	ECG Signal (input)
3	GND	6	ECG Signal (output)

4) USB Interface (Reserved)**WARNING**

- Accessory equipment connected to the analog and digital interfaces must be certified according to the respective IEC/EN standards (e.g. IEC/EN 60950 for data processing equipment and IEC/EN 60601-1 for medical equipment). Furthermore all configuration shall comply with the valid version of the standard IEC/EN 60601-1-1. Therefore anybody, who connects additional equipment to the signal input or output connector to configure a medical system, must make sure that it complies with the requirements of

WARNING

the valid version of the system standard IEC/EN 60601-1-1. If in doubt, consult our technical service department or your local distributor.

2. The summation of leakage current should never exceed leakage current limits while several other units are used at the same time.

2.4 Mains Connection and Switch

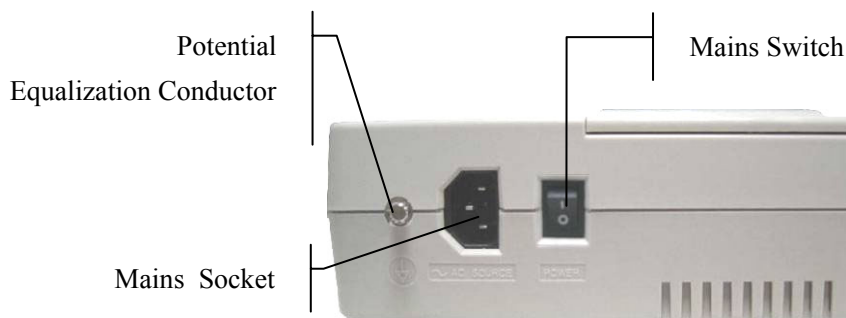

As the above figure shows, on the left side of the main unit are the mains socket, mains switch and potential equalization conductor.

1) Potential Equalization Conductor



The potential equalization conductor provides a connection between the unit and the potential equalization bus bar of the electrical installation.

2) Mains Socket



AC SOURCE: alternating current supply socket

3) Mains Switch

| : On

○ : Off

2.5 Bottom Panel

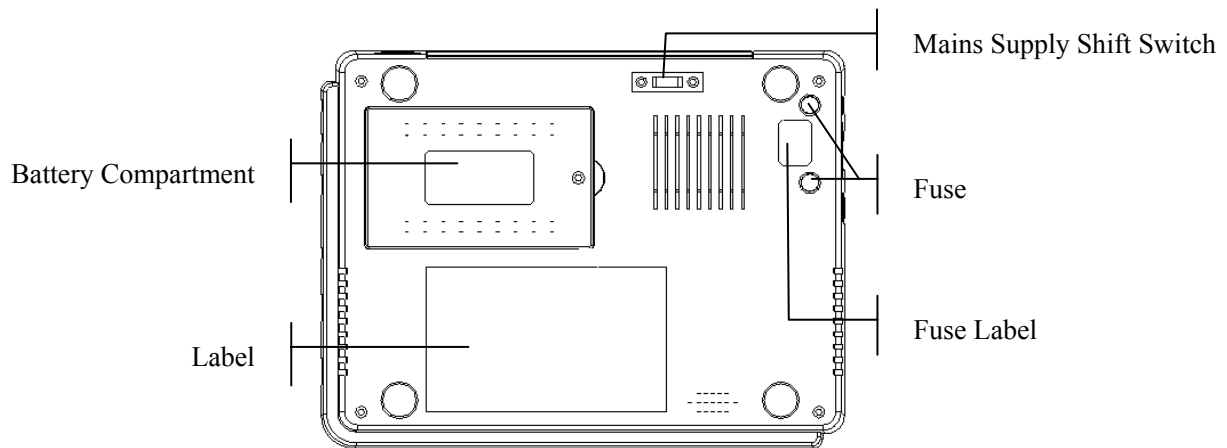

1) Battery Compartment

The battery label indicates the rated voltage and the rated capacity of the rechargeable lithium battery.

Rated voltage: 14.8V, Rated capacity: 2500mAh.

 Attention, consult ACCOMPANYING DOCUMENTS

WARNING

Only qualified service engineers authorized by the manufacturer can open the battery compartment and replace the battery. The battery of the same model and specification provided by the manufacturer must be used.

2) Mains Supply Shift Switch

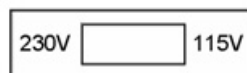

The mains supply with the rated input voltage of 230V (220V-240V~) or 115V (100V-115V~) can be chosen by using the shift switch according to local mains supply specifications.

WARNING

Only qualified installation or service engineers can shift the mains supply shift switch according to local mains supply specifications.

3) Fuse

There are two fuses of the same specifications installed on the bottom of the main unit. The specifications are shown on the fuse label: T400mA250V, Ø5×20mm.

WARNING

Ruptured fuses must only be replaced with those of the same type and rating as the original.

2.6 Function Features

- ◆ Low weight and compact size
- ◆ Well designed membrane key panel for easy operation
- ◆ LCD screen for single channel ECG view
- ◆ Four auto modes and a manual mode are optional
- ◆ General menu for setting parameters
- ◆ Built-in rechargeable lithium battery with large capacity
- ◆ Hint information of lead off, lack of paper, low battery capacity etc.
- ◆ Thermal dot-matrix recorder for high-resolution printout
- ◆ Automatic adjustment of baseline for optimal printing
- ◆ Selectable printing formats, standard single channel or single channel & rhythm lead
- ◆ Standard external input/output interface

Chapter 3 About SE-1 Application Interface

The following sections provide an overview of the main functions in the SE-1 application. After you turn on the device, the main interface pops up. Then you can press the **MENU** key to open the system setup interface.

3.1 About the Main Interface

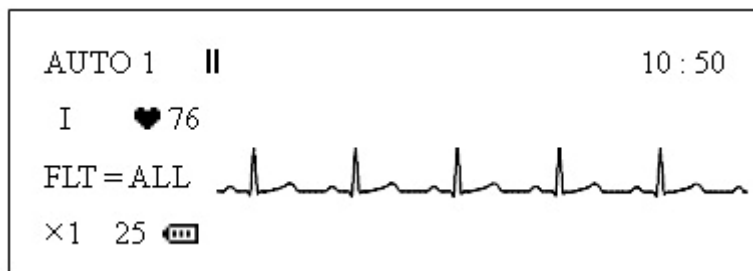

Figure 3-1 Main Interface

The LCD screen can be revolved and settled freely at different angles.

Normally, the contents displayed on the LCD screen include: (described from left to right in row order)

First Row:

- ◆ Working mode (AUTO1, AUTO2, AUTO3, AUTO4 and MANU)
- ◆ **||** stop symbol, which will turn to **▶** during the printing course
- ◆ Hint information (LDOFF, PAPER?, etc.)
- ◆ Current time





Second Row:

- ◆ Current lead (I, II, III, aVR, aVL, aVF, V1, V2, V3, V4, V5, V6)
- ◆ Heart rate **♥** (--, actual heart rate, or OVR)

Third Row:

- ◆ Filter setting (FLT = AC, EMG, ALL, OFF)
- ◆ ECG wave

Fourth Row:

- ◆ Sensitivity (×1, ×2, AGC, · 25, · 5)
- ◆ Paper speed (25, 50)
- ◆ Battery capacity symbol (, , , )
- ◆ When you are setting the ID, sex or age group, the item will be shown here. The hint *BATTERY WEAK* will be shown here when the battery capacity is low.

3.2 About the System Setup Interface

When the main interface is displayed, press the **MENU** key to open the system setup interface. Press the **MENU** key again to return to the main interface.

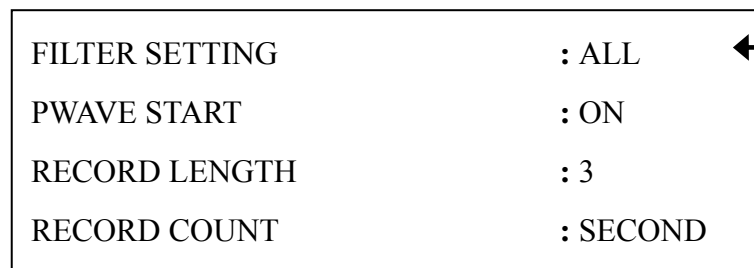





Figure 3-2 System Setup Interface

1. Press the **ID** key (the up or down arrow)   to move the arrow ← on the right of the LCD screen to the item to be changed.

2. Then press the **M/F** or **AGE** key   to select an option for the item.

3. After setting the items, press the **MENU** key  to exit the system setup interface.

Chapter 4 Operation Preparations

CAUTION

Before use, the equipment, patient cable and electrodes should be checked. Replace them if there is any evident defectiveness or aging which may impair the safety or the performance. Make sure that the equipment is in proper working condition.

4.1 Power and Earthling

WARNING

If the integrity of the external protective conductor is in doubt, the equipment should be powered by the built-in rechargeable lithium battery.

Power Supply

The electrocardiograph can be powered either by the mains supply or a built-in rechargeable lithium battery.

1) Mains Supply

The mains socket is on the left side of the unit. If the mains supply is used, connect the power cord to the socket first, and then connect the power cord to the hospital grade outlet.

Operating voltage:	100V-115V~ / 220V-240V~
Operating frequency:	50Hz / 60Hz
Input power:	35VA

Make sure that the mains supply meets the above requirements before power-on, and then press the mains switch. Then the mains supply indicator (⌚) will be lit as well as the battery recharging indicator (→□).

2) Built-in Rechargeable Battery

When the built-in rechargeable lithium battery is used, turn on the unit by pressing the **ON/OFF** key on the key panel directly. Then the battery indicator (□) will be lit and the battery symbol (🔋) will be displayed on the LCD screen. Because of the consumption during the storage and transport course, the battery capacity may not be full. If the symbol (□) and the hint *BATTERY WEAK* are displayed, which means the battery capacity is low, please recharge the battery first.

Please refer to the maintenance section for how to recharge the battery. When the battery is being recharged, SE-1 can be powered by the mains supply at the same time.

WARNING

The potential equalization conductor of the unit should be connected to the potential equalization bus bar of the electrical installation when necessary.

4.2 Loading/Replacing Recorder Paper

The rolled thermal paper with the width of 50mm is used. When the recorder paper runs out or is not loaded, the hint *PAPER?* will appear on the screen. Then you should load or replace the recorder paper immediately.

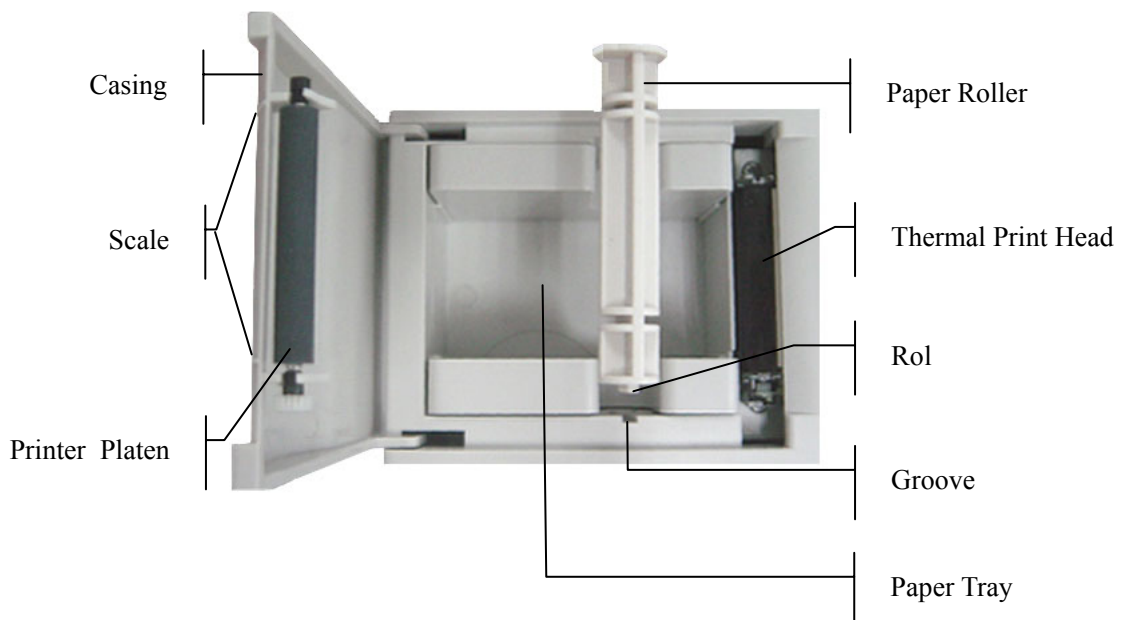

Loading/Replacing Process:

- 1) Place fingers under the two flanges of the recorder casing, pull them upwards directly to release the casing;

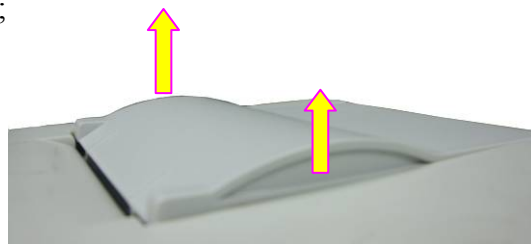

- 2) Take out the paper roller, and remove remainder paper from the roller if necessary;
- 3) Take off the wrapper of the new thermal paper roll, and then put the paper roll through the roller;

- 4) Place the paper and the roller gently in the recorder with the roller pin clicking into the groove;
- 5) Pull about 2cm of paper out with the grid side of the paper facing the thermal print head, and shut the recorder casing with the paper edges in parallel with the scales on the surface of the casing;

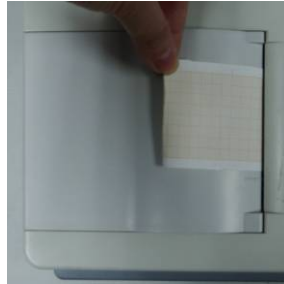

- 6) Press down the recorder casing firmly.

4.3 Preparing the Patient

4.3.1 Instructing the Patient

Before attaching the electrodes, greet the patient and explain the procedure. Explaining the procedure decreases the patient's anxiety. Reassure the patient that the procedure is painless. Privacy is important for relaxation. When possible, prepare the patient in a quiet room or area where others can't see the patient. Make sure that the patient is comfortable. The more relaxed the patient is, the less the ECG will be affected by noise.

4.3.2 Preparing the Skin

Thorough skin preparation is very important. The skin is a poor conductor of electricity and frequently creates artifact that distorts the ECG signals. By performing methodical skin preparation, you can greatly reduce the possibility of the noise caused by muscle tremor and baseline drift, ensuring high-quality ECG waves. There is natural resistance on the skin surface due to dry, dead epidermal cells, oils and dirt.

To Prepare the Skin

1. Shave hair from electrode sites, if necessary. Excessive hair prevents a good connection.
2. Wash the area thoroughly with soap and water.
3. Dry the skin with a gauze pad to increase capillary blood flow to the tissues and to remove the dead, dry skin cells and oils.

4.4 Connecting the Patient Cable to the Electrocardiograph and Electrodes

WARNING

The performance and electric shock protection can be guaranteed only if the original patient cable and electrodes of the manufacturer are used.

The patient cable includes the main cable and the lead wires which can be connected to electrodes according to the colors and the identifiers.

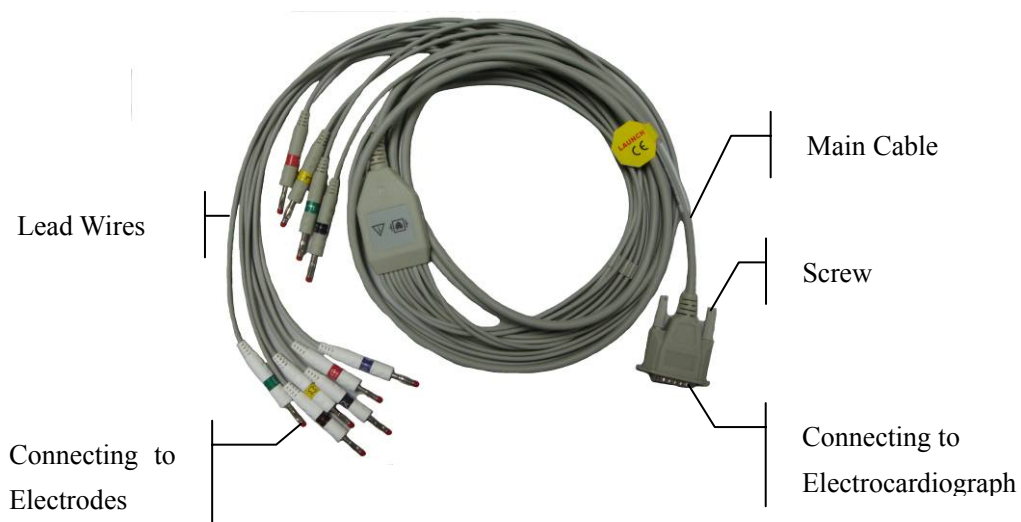

1. Connecting the Patient Cable to the Electrocardiograph

Connect the patient cable to the patient cable socket on the right side of the main unit, and then secure them with two screws.

2. Connecting the Patient Cable to Electrodes

Align all lead wires of the patient cable to avoid twisting, and connect the lead wires to the electrodes. Firmly attach them.

WARNING

This product is CF classified and defibrillation protected only when the original patient cable is used. However, remove electrodes before defibrillation when possible as a safety precaution.

4.5 Attaching Electrodes to the Patient

Chest Electrode:

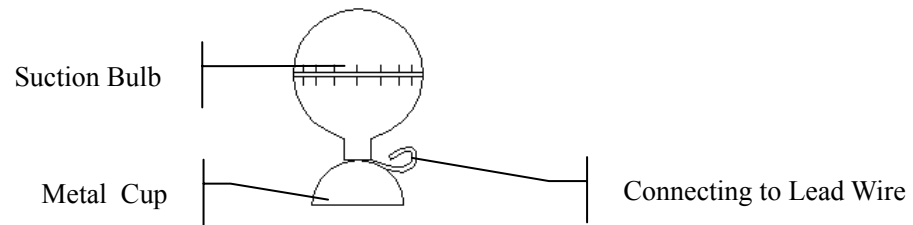

Limb Electrode:

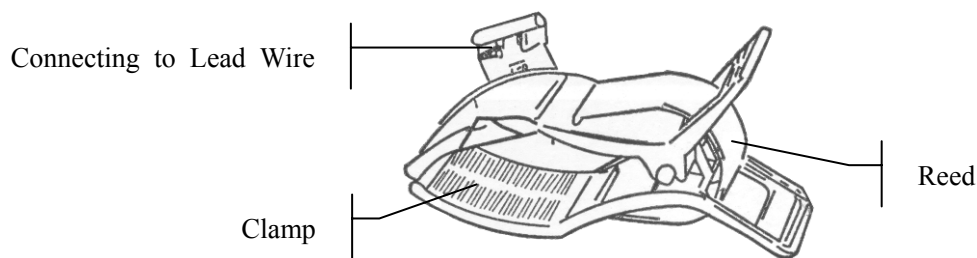

The identifiers and color codes of electrodes used comply with IEC/EN requirements. In order to avoid incorrect connections, the electrode identifiers and color codes are specified in Table 4-1. Moreover the equivalent codes according to American requirements are given in Table 4-1 too.

Table 4-1 Electrodes, Identifiers and Color Codes

Electrodes	European		American	
	Identifiers	Color Codes	Identifiers	Color Codes
Right arm	R	Red	RA	White
Left arm	L	Yellow	LA	Black
Right leg	N or RF	Black	RL	Green
Left leg	F	Green	LL	Red
Chest 1	C1	White/red	V1	Brown/red
Chest 2	C2	White/yellow	V2	Brown/yellow
Chest 3	C3	White/green	V3	Brown/green
Chest 4	C4	White/brown	V4	Brown/ blue
Chest 5	C5	White/black	V5	Brown/orange
Chest 6	C6	White/violet	V6	Brown/violet

As the following figure shows, the positions of chest electrodes on the body surface are

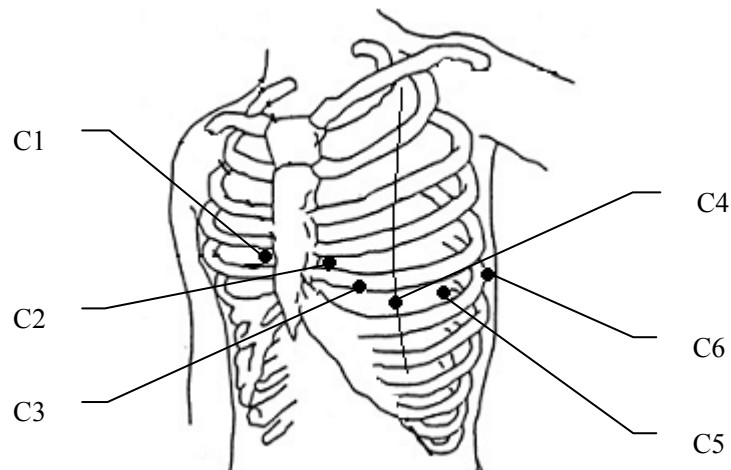

C1: Fourth intercostal space at the right border of the sternum

C2: Fourth intercostal space at the left border of the sternum

C3: Fifth rib between C2 and C4

C4: Fifth intercostal space on the left midclavicular line

C5: Left anterior axillary line at the horizontal level of C4

C6: Left midaxillary line at the horizontal level of C4

The quality of ECG waveform will be affected by the contact resistance between the patient and the electrode. In order to get a high-quality ECG, the skin-electrode resistance must be minimized when you attach electrodes to patients.

Chest Electrode Connection:

- 1) Ensure that the electrodes are clean;
- 2) Align all lead wires of the patient cable to avoid twisting, and connect the lead wires to the corresponding electrodes according to the colors and the identifiers;
- 3) Clean the electrode area on the chest surface with alcohol;
- 4) Daub the round area of 25mm in diameter on each electrode site with gel evenly;
- 5) Place a small amount of gel on the brim of the chest electrode's metal cup;
- 6) Place the electrode on the chest electrode site and squeeze the suction bulb. Unclench it and the electrode is adsorbed on the chest;
- 7) Attach all chest electrodes in the same way.

Limb Electrode Connection:

- 1) Ensure that the electrodes are clean;
- 2) Align all lead wires of the patient cable to avoid twisting, and connect the lead wires to the corresponding electrodes according to the colors and the identifiers;
- 3) Clean the electrode area which is a short distance above the ankle or the wrist with alcohol;
- 4) Daub the electrode area on the limb with gel evenly;
- 5) Place a small amount of gel on the metal part of the limb electrode clamp;
- 6) Connect the electrode to the limb, and make sure that the metal part is placed on the electrode area above the ankle or the wrist;
- 7) Attach all limb electrodes in the same way.

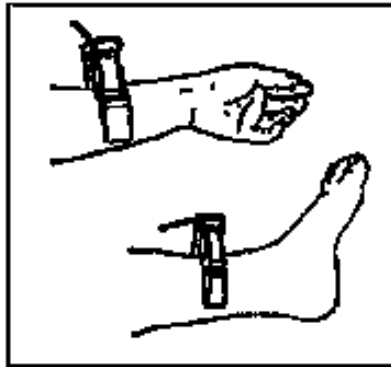

WARNING

1. Make sure that all electrodes are connected to the patient correctly before operation.
 2. Make sure that the conductive parts of electrodes and associated connectors, including neutral electrodes, do not come in contact with earth or any other conducting objects.
 3. Electrodes with defibrillator protection should be used while defibrillating. To avoid a polarization or DC offset voltage, use non-polarizing electrodes (which will not form a DC offset voltage when subjected to a DC current) such as silver/silver-chloride types if there is a situation where there is a likelihood that a defibrillation procedure will be necessary.
 4. Do not touch the patient, bed, table or the equipment while using the ECG together with a defibrillator.
-

4.6 Inspection Before Power-On

In order to avoid safety hazards and get good ECG records, the following inspection procedure is recommended before power-on and operation.

1) Environment:

- ◆ Make sure that there is no electromagnetic interference source around the equipment, especially large medical electrical equipment such as electrosurgical equipment, radiological equipment, magnetic resonance imaging equipment etc. Switch off these devices when necessary.
- ◆ Keep the examination room warm to avoid muscle tremor caused by cold.

2) Power Supply:

- ◆ If the mains supply is used, please check whether the power cord is connected to the unit well. The grounded three-slot outlet should be used.
- ◆ When the battery capacity is low, recharge the battery before use.

3) Patient Cable:

- ◆ Make sure that the patient cable is connected to the unit firmly, and keep it far away from the power cord.

4) Electrodes:

- ◆ Make sure that all electrodes are connected to lead wires of the patient cable correctly.
- ◆ Make sure that all electrodes are connected to the patient correctly.
- ◆ Ensure that the chest electrodes do not contact.

5) Recorder Paper:

- ◆ Ensure that there is enough recorder paper loaded correctly.
- ◆ Make sure that the recorder casing is secured.

6) Patient:

- ◆ The patient should not come into contact with conducting objects such as earth, metal parts etc.
- ◆ Ensure that the patient is warm and relaxed, and breathes calmly.

WARNING

The electrocardiograph is intended to be used by qualified physicians or personnel professionally trained, and they should be familiar with the contents of this user manual before operation.

Chapter 5 Switching On the Electrocardiograph

- ◆ When the mains supply is used, connect the power cord, press the mains switch on the left side of the unit, and then the mains supply indicator (⌚) is lit. Then press the **ON/OFF** key on the key panel to turn on the unit. The equipment information such as the device name, the version number will be displayed on the LCD screen after self-test. Then SE-1 is ready for use.
- ◆ When a built-in rechargeable lithium battery is used, press the **ON/OFF** key on the key panel directly to turn on the unit, and then the battery indicator (🔋) is lit. The equipment information such as the device name, the version number will be displayed on the LCD screen after self-test. Then SE-1 is ready for use.

Chapter 6 Entering Patient Information

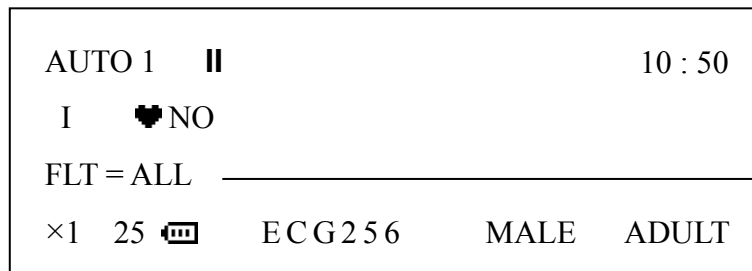

1. Entering ID Number

Press the **ID** key (the up or down arrow)   to set the patient's ID.

Press the up arrow key to increase the ID number and press the down arrow key to decrease the ID number.

After set, the ID number will be displayed for one or two seconds in the last row on the LCD screen, such as *ECG 256* in the above figure.

In the auto or manual mode, if you press **PRINT/STOP** to print a new report, the ID number will increase by one automatically.

2. Entering the Patient's Sex

Press the **M/F** key to set the sex of the patient, which will be displayed for one or two seconds in the last row on the LCD screen, such as *MALE* in the above figure.

3. Entering the Patient's Age Group

Patients are divided into three age groups: **CHILD**, **ADULT**, **OLD**. Press the **AGE** key to set the age group, which will be displayed for one or two seconds in the last row on the LCD screen, such as *ADULT* in the above figure.

Note: The patient information mentioned above can not be set or changed during the printing course.

Chapter 7 Printing ECG Reports

There are four auto modes: **AUTO 1**, **AUTO 2**, **AUTO 3** and **AUTO 4**. Two channels, including a rhythm lead, can be printed together in the **AUTO 4** mode. The lead switch orders in different modes are listed in Table 2-1.

In the auto mode, leads will be switched in order automatically during the printing course. After the ECG wave of one lead is printed for the set time period, the device will switch to print the ECG wave of next lead automatically. There is a blank area on the recorder paper before printing the ECG wave of next lead in the **AUTO1**, **AUTO2** and **AUTO3** modes. Moreover, a 1mV calibration mark will be printed before the ECG wave of each lead. There is no blank area on the recorder paper before printing the ECG wave of next lead in the **AUTO4** mode.



In the manual mode, you can determine the lead to be printed and print the ECG wave of the selected lead continually.

7.1 Auto Mode

Operation Procedures:

- 1) Press the **MODE** key to select an auto mode, which will be displayed in the top left corner of the LCD screen;
- 2) If **AUTO4** is selected, you can select a rhythm lead on the system setup interface.



- 3) Press the **SENS** key  to select an appropriate sensitivity. For details about the signal ranges of different sensitivities, please refer to Section 2.2, “Key Panel and Keys”.
- 4) Press the **MENU** key to open the system setup interface to set the detailed parameters. Press the **MENU** key again to return to the main interface. For details about settings, please refer to Chapter 8 “Settings”.
- 5) Press the **PRINT/STOP** key to begin printing an ECG report. The symbol  means that ECG is being printed now. The device will stop automatically after printing a complete 12-lead ECG report.

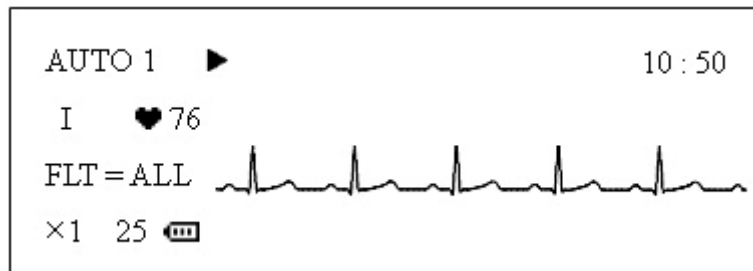

Pressing **PRINT/STOP** during the printing course can stop printing the ECG report. When you begin printing an ECG report later, the system will print the ECG report from the first lead, and the ID number will increase by one automatically. If the ID number needs to be unchanged, you should press the **ID** key to adjust it before printing the report. For details on setting the ID number, see Chapter 6, “Entering Patient Information”.

Note:

1. The working mode can not be changed during the printing course. Stop printing the report before changing the working mode.
2. The **SENS** key is ineffective during the printing course in the auto mode.

7.2 Manual Mode

Operation Procedures:

- 1) Press the **MODE** key to select the **MANU** mode, which will be displayed in the top left corner of the LCD screen.
- 2) Press the Lead switch key to select the lead to be printed.
- 3) Press the **SENS** key  to select an appropriate sensitivity. For details about the signal ranges of different sensitivities, please refer to Section 2.2, “Key Panel and Keys”.
- 4) Press the **MENU** key to open the system setup interface to set the detailed parameters. Press the **MENU** key again to return to the main interface. For details about settings, please refer to Chapter 8 “Settings”.
- 5) Press the **PRINT/STOP** key to begin printing an ECG report.
- 6) Press the **1mV** key to print out a 1mV mark in the ECG report. Press the Lead switch key to switch the lead while printing the ECG report.
- 7) Press the **PRINT/STOP** key to stop printing the ECG report.

7.3 ECG Report

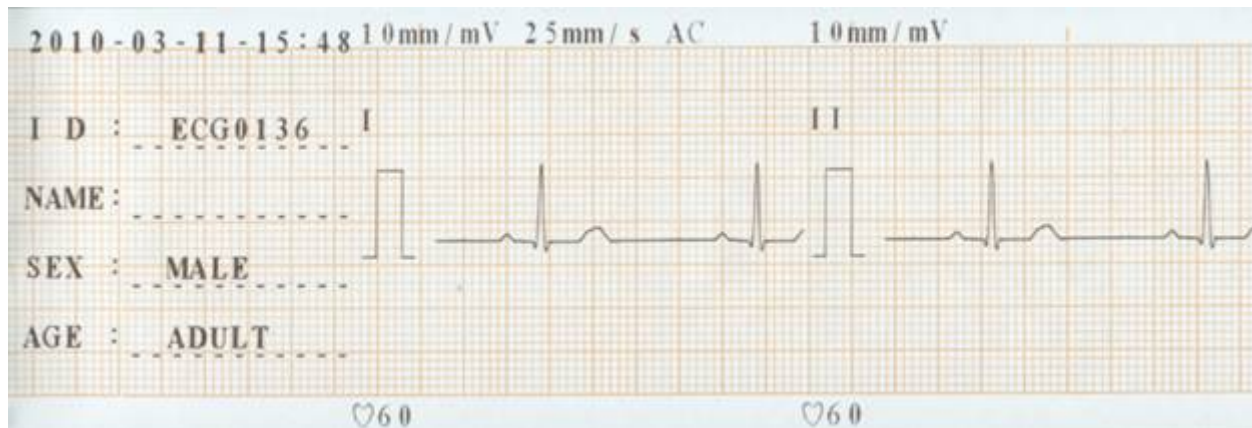

Figure (a) AUTO1

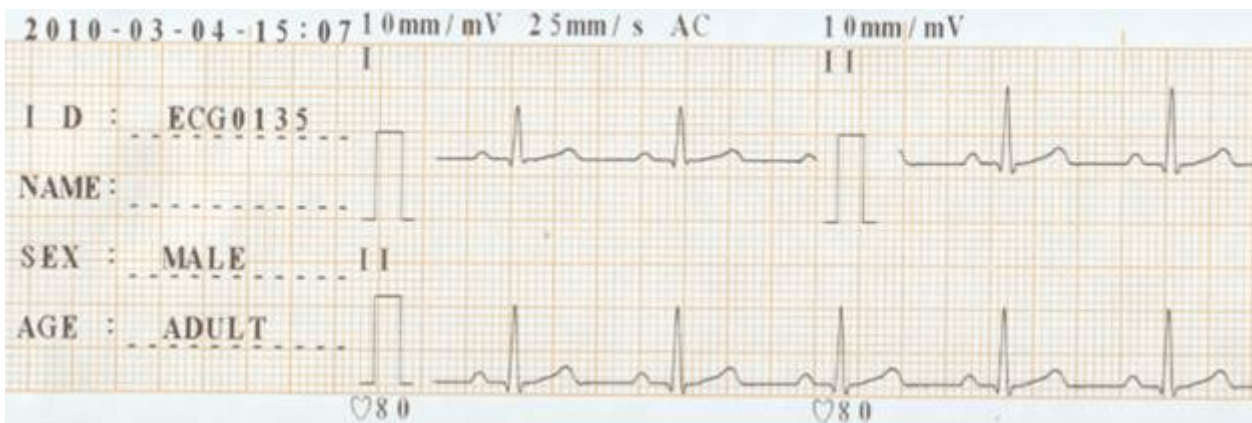

Figure (b) AUTO4

As the above figures show, an ECG report includes the date and time, ID number, name (written by doctors later), sex, age, sensitivity, paper speed, filter settings, lead name, 1mV calibration mark, ECG wave and heart rate.

The lead name and a 1mV calibration mark are printed before the ECG wave of each lead. On the top of the ECG wave of each lead, the sensitivity is printed. The sensitivity of each lead may be different, because it can be changed during the printing course.

Chapter 8 Settings

When the main interface is displayed, press the **MENU** key to open the system setup interface. Press the **MENU** key again to return to the main interface.



The 19 menu items on the system setup interface are listed in Table 8-1. The double-underlined options are default settings.



Table 8-1 Menu Items

No.	Menu Items	Options
1	FILTER SETTING	<u>AC</u> , ALL, OFF, EMG
2	PWAVE START	<u>ON</u> , OFF
3	RECORD LENGTH	2, <u>3</u> , 4, ..., 11, 12
4	RECORD COUNT	<u>SECOND</u> , QRS
5	RECORD SPEED	<u>25</u> , 50 (unit: mm/s)
6	HEARTRATE PRINT	<u>ON</u> , OFF
7	YEAR	0~99
8	MONTH	1~12
9	DAY	1~31
10	HOUR	0~23
11	MINUTE	0~59
12	PRINT HEAD TEST	ON, <u>OFF</u>
13	DEFAULT SETTING	<u>OFF</u> , RESTORE
14	EXTINPUT RECORD	ON, <u>OFF</u>
15	KEY BEEP	<u>ON</u> , OFF
16	QRS BEEP	ON, <u>OFF</u>
17	RHYTHM LEAD	I, <u>II</u> , III, aVR, aVL, aVF V1, V2, V3, V4, V5, V6
18	LOWPASS FILTER	NO, 75HZ, <u>100HZ</u> , 150HZ
19	LANGUAGE	ENG, CHN

Setting Method:

FILTER SETTING	: ALL	←
PWAVE START	: ON	
RECORD LENGTH	: 3	
RECORD COUNT	: SECOND	

1. Press the **ID** key (the up or down arrow)   to move the arrow ← on the right of the LCD screen to the item to be changed.

2. Then press the **M/F** or **AGE** key   to select an option for the item.

3. After setting the items, press the **MENU** key  to exit the system setup interface.

Note: If you set **DEFAULT SETTING** to **RESTORE**, all the items will be restored to the default settings except the date, time and language.

The following sections provide an introduction to the menu items.

8.1 Filter Settings

You can set **FILTER SETTING** to **EMG**, **AC**, **ALL** (both EMG and AC) or **OFF** (no filter). When it is set to **OFF**, the filters will not work. Generally, it is recommended to be set to **ALL** to get a better ECG record.

Note: To pass the distortion test, the electrocardiograph has to be configured with the highest bandwidth in filter settings. Otherwise, ECG signal may be distorted.

8.2 Recording Settings

PWAVE START	: ON
RECORD LENGTH	: 3
RECORD COUNT	: SECOND

RECORD SPEED : 25
HEARTRATE PRINT : ON

Take the above settings for example, the ECG will be printed from a P wave, the printing speed is 25mm/s, the printing length of each lead is 3 seconds, and the heart rate will be printed out on the bottom of the recorder paper. If **RECORD COUNT** is set to **QRS**, the printing length of each lead is three QRS waves.

Note: The printing duration of each lead must be more than 2 seconds. When **RECORD COUNT** is set to **QRS**, if the time period of QRS waves is so short that the printing duration of each lead is less than 2 seconds, printing will continue until it reaches 2 seconds.

8.3 Date and Time Settings

YEAR : 4
MONTH : 8
DAY : 6
HOUR : 14
MINUTE : 25

As the above settings show, the date and the time is set to Aug. 6th, 2004, 14:25 PM. The time will be displayed on the LCD screen. The date and the time will be printed in the ECG report.

Note: Please set DATE&TIME correctly when it's the first time you use the electrocardiograph.

8.4 Print Head Test

PRINT HEAD TEST : OFF

The print head test is used to check whether the print head can work normally. By default, **PRINT HEAD TEST** is set to **OFF**. After the recorder paper is loaded, set **PRINT HEAD TEST** to **ON** by pressing the **M/F** or **Age** key. Then the triangle waves in effective paper width will be printed. The status of the print head can be estimated from these triangle waves. Press the **M/F** or **Age** key to stop the printing test.

8.5 External Input/Output Settings

The external input/output signal interface is equipped in the electrocardiograph, through which SE-1 can receive ECG signals from external equipment, and transmit ECG signals to external equipment. There are two options: **ON** and **OFF**.

8.6 Key Beep and QRS Beep Settings

KEY BEEP : ON

QRS BEEP : OFF

When **KEY BEEP** is set to **ON**, there is a short beep when the keys on the key panel are pressed.

When **QRS BEEP** is set to **ON**, there is a short beep when an R wave is detected.

8.7 Rhythm Lead Settings

RHYTHM LEAD : II

In the **AUTO4** mode, ECG waves of a lead and a rhythm lead can be printed. The rhythm lead can be any one of 12 standard leads: I, II, III, aVR, aVL, aVF, V1, V2, V3, V4, V5, and V6.

Chapter 9 Switching Off the Electrocardiograph

When the built-in battery is used, press the **ON/OFF** key directly to turn off the unit.

When the mains supply is used, press the **ON/OFF** key, and then press the mains switch on the left side of the unit. Pull out the plug from the outlet.

Chapter 10 Hint Information

Hint information will be displayed on the LCD screen when there is something wrong. Hint information provided by the electrocardiograph and the corresponding causes are listed in Table 10-1.

Table 10-1 Hint Information and Causes

Hint Information	Causes
LDOFF	Electrodes fall off the patient or the patient cable falls off the unit.
PAPER?	Recorder paper runs out or is not loaded.
BATTERY WEAK	The battery capacity is low.
--	The heart rate is over 300BPM or below 30BPM, or the heart rate has not been detected in 2 seconds.
OVR	The ECG signal exceeds the measurable range of the set sensitivity.

Chapter 11 Cleaning, Care and Maintenance

Use only the EDAN-approved substances and methods listed in this chapter to clean or disinfect your equipment. Warranty does not cover damage caused by using unapproved substances or methods.

Edan Instruments has validated the cleaning and disinfection instructions provided in this User Manual. It is the responsibility of the healthcare professional to ensure that the instructions are followed so as to ensure adequate cleaning and disinfection.

11.1 General Points

Keep your electrocardiograph and accessories free of dust and dirt. To prevent the device from damage, please follow the instructions:

- Use only the recommended cleaning agents and disinfectants listed in this manual. Others may cause damage (not covered by warranty), reduce product lifetime or cause safety hazards.
- Always dilute according to the manufacturer's instructions.
- Unless otherwise specified, do not immerse any part of the equipment or any accessories in liquid.
- Do not pour liquid onto the equipment.
- Do not allow liquid to enter the case.
- Never use abrasive material (such as steel wool or silver polish).
- Inspect the electrocardiograph and reusable accessories after they are cleaned and disinfected.

CAUTION

If you spill liquid on the equipment or accessories, or they are accidentally immersed in liquid, contact your service personnel or EDAN service engineer.

11.2 Cleaning

If the equipment or accessory has been in contact with the patient, then cleaning and disinfection is required after each use.

The validated cleaning agents for cleaning the electrocardiograph and reusable accessories are:

- Mild near neutral detergent
- Ethanol (75%)
- Isopropanol (70%)

Cleaning agents should be applied or removed using a clean, soft, non-abrasive cloth or paper towel.

11.2.1 Cleaning the Main Unit

WARNING

Turn off the power before cleaning. The mains supply must be switched off if it is used.

1. Switch off the main unit and disconnect it from the power cord.
2. Wipe the exterior surface of the equipment using a soft cloth dampened with the cleaning solution until no visible contaminants remain.
3. Wipe off the cleaning solution with a fresh cloth or towel dampened with tap water after cleaning until no visible cleaning agent remains.
4. Dry the main unit in a ventilated and cool place.

11.2.2 Cleaning the Patient Cable

1. Wipe the patient cable with a soft cloth dampened with the cleaning solution until no visible contaminants remain.
2. Wipe off the cleaning solution with a fresh cloth or towel dampened with tap water after cleaning until no visible cleaning agent remains.
3. Wipe off with a dry cloth to remove residual moisture.
4. Leave the patient cable to air dry.

CAUTION

Any remainder of cleaning solution should be removed from the main unit and the patient cable after cleaning.

11.2.3 Cleaning the Reusable Electrodes

1. Wipe off with a soft cloth to remove residual gel.
2. Wipe the suction bulbs of chest electrodes and the clamps of limb electrodes with a soft cloth

dampened with the cleaning solution until no visible contaminants remain.

3. Wipe off the cleaning solution with a fresh cloth or towel dampened with tap water after cleaning until no visible cleaning agent remains.
4. Wipe off with a dry cloth to remove residual moisture.
5. Leave the suction bulbs and clamps to air dry.

11.3 Disinfection

To avoid permanent damage to the equipment, it is recommended that disinfection is performed only when it is considered as necessary according to your hospital's regulations.

Clean the equipment and reusable accessories before they are disinfected. The validated disinfectants for disinfecting the electrocardiograph and reusable accessories are:

- Ethanol (75%)
- Isopropanol (70%)

If Ethanol or Isopropanol is used for both cleaning and disinfecting, then a new cloth is required to be used for the disinfection step.

CAUTION

1. Do not use high-temperature, high-pressure vapour or ionizing radiation as disinfection methods.
 2. Do not use chloric disinfectant such as chloride, sodium hypochlorite etc.
 3. Clean and disinfect reusable electrodes after each use.
-
-

11.3.1 Disinfecting the Main Unit

WARNING

Turn off the power before disinfection. The mains supply must be switched off if it is used.

1. Switch off the main unit and disconnect it from the power cord.
2. Wipe the exterior surface of the equipment using a soft cloth dampened with the disinfectant solution.
3. Wipe off the disinfectant solution with a dry cloth after disinfection if necessary.
4. Dry the main unit for at least 30 minutes in a ventilated and cool place.

11.3.2 Disinfecting the Patient Cable

1. Wipe the patient cable with a soft cloth dampened with the disinfectant solution.
2. Wipe off the disinfectant solution with a dry cloth after disinfection.
3. Leave the patient cable to air dry for at least 30 minutes.

11.3.3 Disinfecting the Reusable Electrodes

1. Wipe the suction bulbs of chest electrodes and the clamps of limb electrodes with a soft cloth dampened with the disinfectant solution.
2. Wipe off the disinfectant solution with a dry cloth after disinfection.
3. Leave the suction bulbs and clamps to air dry for at least 30 minutes.

11.4 Care and Maintenance

11.4.1 Recharge and Replacement of Battery

1) Capacity Identification

The current capacity of the rechargeable battery can be identified according to the battery symbol in the last row on the LCD screen.

: Capacity is full



: Capacity is not full but enough



: Capacity is limited, and recharge should be taken into account.

: Capacity is low, and the hint *BATTERY WEAK* will be displayed on the LCD screen.

The battery should be recharged immediately.

2) Recharge

The electrocardiograph is equipped with the recharge control circuit together with the built-in rechargeable lithium battery. When the unit is connected to the mains supply, the battery will be recharged automatically. Then the battery recharging indicator () and the mains supply indicator () will be lit at the same time. During the recharging course, the symbol  flashes in the last row of the LCD screen. When the battery capacity is full, the

symbol  stops flashing, and the battery recharging indicator lamp () is black. When SE-1 is turned off, the battery recharging indicator lamp () is still lit because the equipment can not monitor the recharge status, so you need to turn on the device to verify the recharge status.

Because of the capacity consumption during the storage and transport course, the battery capacity is not full when it is used for the first time. Battery recharge should be considered before the first use. If you do not use the equipment for a long time, please take out the battery, and charge it once every six months.

3) Replacement

When the useful life of the battery is over, or foul smell and leakage are found, please contact the manufacturer or the local distributor for replacement.

WARNING

1. Only qualified service engineers authorized by the manufacturer can open the battery compartment and replace the battery. The battery of the same model and specification provided by the manufacturer must be used.
2. Danger of explosion -- Do not reverse the anode and the cathode when installing the battery.
3. Remove the battery from the electrocardiograph when the electrocardiograph is not used for a long time.
4. If the battery is stored alone and not used for a long time, we recommend that the battery should be charged at least once every 6 months to prevent overdischarge.
5. When the battery's useful life is over, contact the manufacturer or the local distributor for disposal or dispose of the battery according to local regulations.

11.4.2 Recorder Paper

Storage Requirements:

- ◆ Recorder paper should be stored in a dry, dark and cool area, avoiding excessive temperature, humidity and sunshine.
- ◆ Do not put the recorder paper under fluorescence for a long time.
- ◆ Make sure that there is no polyvinyl chloride or other chemicals in the storage environment, which will lead to color change of the paper.
- ◆ Do not overlap the recorder paper for a long time, or else the ECG reports may

trans-print each other.

Note: Recorder paper provided by the manufacturer should be used. Other paper may shorten the life of the thermal print head. The deteriorated print head may lead to illegible ECG reports and block the advance of the paper.

11.4.3 Maintenance of Main Unit, Patient Cable and Electrodes

The following safety checks should be performed at least every 24 months by a qualified person who has adequate training, knowledge, and practical experience to perform these tests.

- a) Inspect the equipment and accessories for mechanical and functional damage.
- b) Inspect the safety related labels for legibility.
- c) Inspect the fuse to verify compliance with the rated current and circuit-breaking characteristics.
- d) Verify that the device functions properly as described in the instructions for use.
- e) Test the protection earth resistance according to IEC/EN 60601-1: Limit: 0.1 ohm.
- f) Test the earth leakage current according to IEC/EN 60601-1: Limit: NC 500 μ A, SFC 1000 μ A.
- g) Test the enclosure leakage current according to IEC/EN 60601-1: Limit: NC 100 μ A, SFC 500 μ A.
- h) Test the patient leakage current according to IEC/EN 60601-1: Limit: NC a.c. 10 μ A, d.c. 10 μ A; SFC a.c. 50 μ A, d.c. 50 μ A.
- i) Test the patient auxiliary current according to IEC/EN 60601-1: Limit: NC a.c. 10 μ A, d.c. 10 μ A; SFC a.c. 50 μ A, d.c. 50 μ A.
- j) Test the patient leakage current under single fault condition with mains voltage on the applied part according to IEC/EN 60601-1: Limit: 50 μ A (CF).
- k) Test the essential performance according to IEC/EN 60601-2-25, or methods recommended by the hospital or local distributor.

The leakage current should never exceed the limit. The data should be recorded in an equipment log. If the device is not functioning properly or fails any of the above tests, the device has to be repaired.

WARNING

Failure on the part of the responsible individual hospital or institution employing this equipment to implement a satisfactory maintenance schedule may cause undue equipment failures and possible health hazards.

1) Main Unit

- ◆ Avoid excessive temperature, sunshine, humidity and dirt.
- ◆ Put the dustproof coat on the main unit after use and prevent shaking it violently when moving it to another place.
- ◆ Prevent any liquid from seeping into the equipment; otherwise the safety and the performance of the electrocardiograph can not be guaranteed.

2) Patient Cable

- ◆ Integrity of the patient cable, including the main cable and lead wires, should be checked regularly. Make sure that it is conductible.
- ◆ Do not drag or twist the patient cable with excessive stress while using it. Hold the connector plug instead of the cable when connecting or disconnecting the patient cable.
- ◆ Align the patient cable to avoid twisting, knotting or crooking at a closed angle while using it.
- ◆ Store the lead wires in a big wheel to prevent any people from stumbling.
- ◆ Once damage or aging of the patient cable is found, replace it with a new one immediately.

3) Electrodes

- ◆ Electrodes must be cleansed after use and make sure there is no remainder gel on them.
- ◆ Keep suction bulbs of chest electrodes away from sunshine and excessive temperature.
- ◆ After long-term use, the surfaces of electrodes will be oxidized because of erosion and other causes. By this time, electrodes should be replaced to achieve high-quality ECG records.

CAUTION

The device and accessories are to be disposed of according to local regulations after their useful lives. Alternatively, they can be returned to the dealer or the manufacturer for recycling or proper disposal.

Chapter 12 Accessories and Ordering Information

WARNING

Only the patient cable and other accessories supplied by the manufacturer can be used. Or else, the performance and electric shock protection can not be guaranteed.

Table 12-1 Standard Accessory List

Accessory	Part Number
Power Cord	01.13.036638
Patient Cable (European)	01.57.471016
	01.57.471500
Patient Cable (American)	01.57.471017
	01.57.471499
Adult Chest Electrodes	01.57.040163
Adult Limb Electrodes	01.57.040162
Paper roller	01.51.19992
Thermal Recorder paper (Roll, 50mm×30m)	01.57.19917
Fuse	21.21.064183
Rechargeable Li-ion Battery	21.21.064149

Table 12-2 Optional Accessory List

Accessory	Part Number
Patient Cable (European)	01.57.107402 (Banana Style)
	01.57.107581 (Snap Style)
	01.57.107583 (Grabber Style)
Patient Cable (American)	01.57.110375 (Banana Style)

	01.57.107582 (Snap Style)
	01.57.107584 (Grabber Style)
Pediatric Chest Electrodes	01.57.040168
Pediatric Limb Electrodes	01.57.040169
Snap/Banana Socket Adapters	01.13.107449
Clip/Snap/Banana Socket Adapter	01.57.040172
Alligator Clip/Banana Socket Adapters	01.57.040173
Adult Disposable Adhesive Electrodes	01.57.471056
Pediatric Disposable Adhesive Electrodes	01.57.471057
Disposable Resting electrodes	01.57.471031
Grounding Wire	01.13.114114
ECG Bag	01.56.465628
MT-201 Trolley	83.61.111847
CA-100 Lead wire bracket	02.04.111902

SE-1 and accessories are available by contacting the manufacturer or your local distributor.

NOTE: The part name may vary depending on context, but the part number is constant.

Chapter 13 Warranty and Service

13.1 Warranty

EDAN warrants that EDAN's products meet the labeled specifications of the products and will be free from defects in materials and workmanship that occur within warranty period.

The warranty is void in cases of:

- a) damage caused by mishandling during shipping.
- b) subsequent damage caused by improper use or maintenance.
- c) damage caused by alteration or repair by anyone not authorized by EDAN.
- d) damage caused by accidents.
- e) replacement or removal of serial number label and manufacture label.

If a product covered by this warranty is determined to be defective because of defective materials, components, or workmanship, and the warranty claim is made within the warranty period, EDAN will, at its discretion, repair or replace the defective part(s) free of charge. EDAN will not provide a substitute product for use when the defective product is being repaired.

13.2 Contact information

If you have any question about maintenance, technical specifications or malfunctions of devices, contact your local distributor.

Alternatively, you can send an email to EDAN service department at: support@edan.com.cn.

Appendix 1 Technical Specifications

A1.1 Safety Specifications

Standards:	IEC 60601-1:2005/A1:2012 EN 60601-1:2006/A1:2013 IEC 60601-1-2:2007 EN 60601-1-2:2007/AC:2010 IEC 60601-2-25:2011	
Anti-electric-shock type:	Class I with internal power supply	
Anti-electric-shock degree:	Type CF	
Degree of protection against harmful ingress of water:	Ordinary equipment (Sealed equipment without liquid proof)	
Disinfection/sterilization method:	Refer to the user manual for details	
Degree of safety of application in the presence of flammable gas:	Equipment not suitable for use in the presence of flammable gas	
Working mode:	Continuous operation	
EMC:	CISPR 11 Group 1, Class A	
Patient Leakage Current:	NC	<10 μ A (AC) / <10 μ A (DC)
	SFC	<50 μ A (AC) / <50 μ A (DC)
Patient Auxiliary Current:	NC	<10 μ A (AC) / <10 μ A (DC)
	SFC	<50 μ A (AC) / <50 μ A (DC)
Dielectric Strength:	4000V rms	

A1.2 Environment Specifications

	Transport & Storage	Working
Temperature:	-20°C (-4°F) ~ +55°C (+131°F)	+5°C (+41°F) ~ +40°C (+104°F)
Relative Humidity:	25%RH~93%RH Non-Condensing	25%RH~80%RH Non-Condensing
Atmospheric Pressure:	70 kPa ~106 kPa	86 kPa ~106 kPa

A1.3 Physical Specifications

Dimensions	290mm×220mm×85mm, ±2mm
Weight	Approx. 2.0 kg (4.4 lbs) (Excluding recorder paper and battery)
Display	192 × 64 dot single color LCD screen

A1.4 Power Supply Specifications

Mains Supply:	Operating Voltage = 100V-115V~/220V-240V~
	Operating Frequency = 50Hz/60Hz
	Input Power = 35VA
Built-in Lithium Battery Pack:	Rated voltage = 14.8V
	Rated capacity = 2500mAh
	When the battery is fully charged, the electrocardiograph can work normally for nearly 6.5 hours; and it can continually print for about 4 hours in the manual mode or print about 150 ECG reports in the auto mode.
	Charge mode: Constant current/voltage
	Charge current (standard) = 0.16C ₅ A (360mA)
	Charge voltage (standard) = (16.8-0.1V)
	Necessary Charge time: 5 hours
	Cycle life ≥ 300 times

Power Consumption:	35VA
Fuse:	T400mA H250V, Ø5×20mm.

A1.5 Performance Specifications

Recording	
Recorder:	Thermal dot-matrix recorder
Printing Density	8 dots per mm / 200 dots per inch (amplitude axes) 40 dots per mm / 1000 dots per inch (time axes, @ 25 mm/s)
Recorder Paper:	Rolled thermal paper: 50mm×30m
Effective Width:	48 mm
Paper Speed:	25mm/s, 50mm/s
Accuracy of data:	±3%
HR Recognition	
Technique:	Peak-peak detection
HR Range:	30 BPM ~ 300 BPM
Accuracy:	±1 BPM
ECG Unit	
Leads:	12 standard leads
Acquisition Mode:	One lead
A/D:	12 bits
Resolution:	2.52uV/LSB
Time Constant:	≥3.2s
Frequency Response:	0.05Hz ~ 150Hz (-3dB)
Sensitivity:	2.5mm/mV, 5mm/mV, 10mm/mV, 20 mm/mV, AGC
Input Impedance:	≥50MΩ(10Hz)
Input Circuit Current:	≤0.05μA
Input Voltage Range	≤±5 mVpp

Calibration Voltage:	1mV±3%
DC Offset Voltage:	±300mV
Minimum Amplitude:	20 μVp-p
Noise:	≤12.5μVp-p
Filter	EMG Filter: 35Hz (-3dB)
	AC/DFT Filter: 50Hz/60Hz (-20dB)
CMRR	≥110dB
Sampling Frequency	1000 Hz
External Input/Output (Optional)	
Input	≥100kΩ; Sensitivity 10mm/V±5%; Single ended
Output	≤100Ω; Sensitivity 1V/mV±5%; Single ended

Note: Operation of the equipment below the minimum amplitude may cause inaccurate results.

Appendix 2 EMC Information

Guidance and manufacture's declaration – electromagnetic emissions- for all EQUIPMENT and SYSTEMS

Guidance and manufacture's declaration – electromagnetic emission		
The SE-1 Electrocardiograph is intended for use in the electromagnetic environment specified below. The customer or the user of the SE-1 Electrocardiograph should assure that it is used in such an environment.		
Emission test	Compliance	Electromagnetic environment – guidance
RF emissions CISPR 11	Group 1	The SE-1 Electrocardiograph uses RF energy only for its internal function. Therefore, its RF emissions are very low and are not likely to cause any interference in nearby electronic equipment.
RF emission CISPR 11	Class A	The SE-1 Electrocardiograph is suitable for use in all establishments, other than domestic and those directly connected to the public low-voltage power supply network that supplies buildings used for domestic purposes.
Harmonic emissions IEC 61000-3-2	Class A	
Voltage fluctuations/ flicker emissions IEC 61000-3-3	Complies	

Guidance and manufacture's declaration – electromagnetic immunity – For all EQUIPMENT and SYSTEMS

Guidance and manufacture's declaration – electromagnetic immunity			
The <i>Electrocardiograph</i> is intended for use in the electromagnetic environment specified below. The user of <i>Electrocardiograph</i> should assure that it is used in such an environment.			
Immunity test	IEC 60601 test level	Compliance level	Electromagnetic environment - guidance
Electrostatic discharge (ESD) IEC 61000-4-2	±6 kV contact ±8 kV air	±6 kV contact ±8 kV air	It is recommended the use of antistatic materials. If floor are covered with synthetic material, the relative humidity should be at least 50%.
Electrical fast transient/burst IEC 61000-4-4	±2 kV for power supply lines	±1 kV for power supply lines	It is recommended the use of filters on power input lines and enough separation between signal lines and power lines.

Surge IEC 61000-4-5	± 1 kV line to line ± 2 kV line to ground	± 1 kV line to line ± 2 kV line to ground	Mains power quality should be that of a typical commercial or hospital environment.
Voltage dips, short interruptions and voltage variations on power supply input lines IEC 61000-4-11	$< 5\% U_T$ ($> 95\%$ dip in U_T) for 0.5 cycle $40\% U_T$ (60% dip in U_T) for 5 cycles $70\% U_T$ (30% dip in U_T) for 25 cycles $< 5\% U_T$ ($> 95\%$ dip in U_T) for 5 sec	$< 5\% U_T$ ($> 95\%$ dip in U_T) for 0.5 cycle $40\% U_T$ (60% dip in U_T) for 5 cycles $70\% U_T$ (30% dip in U_T) for 25 cycles $< 5\% U_T$ ($> 95\%$ dip in U_T) for 5 sec	Mains power quality should be that of a typical commercial or hospital environment.
Power frequency (50Hz/60Hz) magnetic field IEC 61000-4-8	3A/m	3A/m	Power frequency magnetic fields should be at levels characteristic of a typical location in a typical commercial or hospital environment.
NOTE U_T is the a.c. mains voltage prior to application of the test level.			

**Guidance and manufacture's declaration – electromagnetic immunity –
For EQUIPMENT and SYSTEMS that are not LIFE-SUPPORTING**

Guidance and manufacture's declaration – electromagnetic immunity			
The <i>Electrocardiograph</i> is intended for use in the electromagnetic environment specified below. The customer or the user of <i>Electrocardiograph</i> should assure that it is used in such an environment.			
Immunity test	IEC 60601 test level	Compliance level	Electromagnetic environment - guidance
Conducted RF IEC 61000-4-6 Radiated RF IEC 61000-4-3	3 V _{rms} 150 kHz to 80 MHz 3 V/m 80 MHz to 2.5 GHz	3 V _{rms} 3 V/m	<p>Portable and mobile RF communications equipment should be used no closer to any part of the <i>Electrocardiograph</i>, including cables, than the recommended separation distance calculated from the equation applicable to the frequency of the transmitter.</p> <p>Recommended separation distance</p> $d = 1.2\sqrt{P}$ $d = 1.2\sqrt{P} \quad 80 \text{ MHz to } 800 \text{ MHz}$ $d = 2.3\sqrt{P} \quad 800 \text{ MHz to } 2.5 \text{ GHz}$ <p>Where P is the maximum output power rating of the transmitter in watts (W) according to the transmitter manufacturer and d is the recommended separation distance in metres (m). Field strengths from fixed RF transmitters, as determined by an electromagnetic site survey,^a should be less than the compliance level in each frequency range.^b Interference may occur in the vicinity of equipment marked with the following symbol:</p> 
NOTE 1 At 80 MHz and 800 MHz, the higher frequency range applies.			
NOTE 2 These guidelines may not apply in all situations. Electromagnetic propagation is affected by absorption and reflection from structures, objects and people.			
^a Field strengths from fixed transmitters, such as base stations for radio (cellular/cordless)			

telephones and land mobile radios, amateur radio, AM and FM radio broadcast and TV broadcast cannot be predicted theoretically with accuracy. To assess the electromagnetic environment due to fixed RF transmitters, an electromagnetic site survey should be considered. If the measured field strength in the location in which the *Electrocardiograph* is used exceeds the applicable RF compliance level above, the *Electrocardiograph* should be observed to verify normal operation. If abnormal performance is observed, additional measures may be necessary, such as reorienting or relocating the *Electrocardiograph*.

^b Over the frequency range 150 kHz to 80 MHz, field strengths should be less than 3 V/m.

**Recommended separation distances between portable and mobile
RF communications equipment and the EQUIPMENT or SYSTEM –
For EQUIPMENT or SYSTEM that are not LIFE-SUPPORTING**

Recommended separation distances between portable and mobile RF communications equipment and electrocardiograph			
The electrocardiograph is intended for use in an electromagnetic environment in which radiated RF disturbances are controlled. The customer or the user of the electrocardiograph can help prevent electromagnetic interference by maintaining a minimum distance between portable and mobile RF communications equipment (transmitters) and the electrocardiograph as recommended below, according to the maximum output power of the communications equipment.			
Rated maximum output power of transmitter (W)	Separation distance according to frequency of transmitter (m)		
	150 kHz to 80 MHz $d = 1.2\sqrt{P}$	80 MHz to 800 MHz $d = 1.2\sqrt{P}$	800 MHz to 2.5 GHz $d = 2.3\sqrt{P}$
0.01	0.12	0.12	0.23
0.1	0.38	0.38	0.73
1	1.2	1.2	2.3
10	3.8	3.8	7.3
100	12	12	23
For transmitters rated at a maximum output power not listed above, the recommended separation distance d in meters (m) can be estimated using the equation applicable to the frequency of the transmitter, where P is the maximum output power rating of the transmitter in watts (W) according to the transmitter manufacturer.			
NOTE 1 At 80 MHz and 800 MHz, the separation distance for the higher frequency range applies.			
NOTE 2 These guidelines may not apply in all situations. Electromagnetic propagation is affected by absorption and reflection from structures, objects and people.			

Appendix 3 Abbreviation

Abbr	English
ECG	Electrocardiogram/Electrocardiograph
HR	Heart Rate
aVF	Left Foot Augmented Lead
aVL	Left Arm Augmented Lead
aVR	Right Arm Augmented Lead
LA	Left Arm
LL	Left Leg
RA	Right Arm
RL	Right Leg
ID	Identification
AC	Alternating Current
USB	Universal Serial Bus
AGC	Auto Gain Control

P/N: 01.54.019929
MPN: 01.54.019929016



EC REPRESENTATIVE

Shanghai International Holding Corp. GmbH (Europe)
Eiffestrasse 80, D-20537 Hamburg Germany
TEL: +49-40-2513175 FAX: +49-40-255726
E-mail: shholding@hotmail.com

EDAN INSTRUMENTS, INC.

#15 Jinhui Road, Jinsha Community, Kengzi Sub-District
Pingshan District, 518122 Shenzhen, P.R.China
Email: info@edan.com.cn
TEL: +86-755-2689 8326 FAX: +86-755-2689 8330

www.edan.com.cn