

ECG TASCABILE CARDIO-C - 3 DERIVAZIONI CARDIO-C POCKET ECG - 3 CHANNEL ECG CARDIO-C POCKET - 3 CANAUX CARDIO-C POCKET ECG - 3 CANALES

Manuale utente - User manual - Notice d'utilisation - Manual de uso



ATTENZIONE: Gli operatori devono leggere e capire completamente questo manuale prima di utilizzare il prodotto.

ATTENTION: The operators must carefully read and completely understand the present manual before using the product.

AVIS: Les opérateurs doivent lire et bien comprendre ce manuel avant d'utiliser le produit.

ATENCIÓN: Los operadores tienen que leer y entender completamente este manual antes de utilizar el producto.

REF 33245



Fabbricante/Manufacturer:
Shenzhen Creative Industry Co., Ltd. 2/F Block 3 Nanyou
Tian'an Industry Town - 518054 Shenzhen, GD - P.R.C.



Shanghai International Trading Corp. GmbH (Hamburg)
Eiffestrasse 80, 20537 Hamburg - Germany



Instructions to User

Dear Users,

Thank you very much for purchasing our product. Please read the manual very carefully before using this device.

These instructions describe the operating procedures to be followed strictly. Failure to follow these instructions may cause measuring abnormality, device damage, or personal injury.

The manufacturer reserves the right to improve and amend this manual at any time without prior notice.

Version of This Manual: Ver1.1

All rights reserved.

WARMING

1. Check the device to make sure that there is no visible damage that may affect user's safety and measurement performance. Stop using the unit, when there is obvious damage.
2. Stop using the ECG cable if it is damaged, please change a new one.
3. Do NOT make diagnosis oneself by the measurement and measurement results, always consult the doctor if abnormal information is presented frequently.
4. It is NOT designed or intended for medical diagnosis.
5. It is NOT designed or intended for therapy purpose.
6. Do NOT use the device in the bathroom or moist circumstance.
7. Do NOT operate in the environment where strong electro-magnetic interference exists.
8. Necessary service must be performed by qualified service engineers ONLY.
9. Clinical ECG examination is suggested for normal examination of your heart condition.
10. Connect/Disconnect data cable to the monitor gently and carefully, do NOT wring or shake the data cable plug with force to insert into or unplug from data interface port, or the data interface port may be damaged.
11. When the ECG amplifier is overload or saturation due to lead off or poor contacts between electrode and the skin, the monitor will prompt "Contact?" to remind the operator.
12. Do not touch the metal electrodes or place the electrodes of lead wire on patient for ECG measurement while the USB cable is connected to PC, electrical hazard will be caused by the leakage current.
13. ECG electrodes, lead wires and cable are not allowed to contact any other conductive parts.
14. It is strongly recommended to use Ag /AgCl (Silver Chloride) electrode to make sure the ECG signal quality is good.
15. Dispose of the expired device and its accessories according to applicable local regulations.





TABLE OF CONTENTS

Chapter 1	OVERVIEW	42
1.1	Appearance.....	42
1.2	Name and Model.....	42
1.3	Structure.....	43
1.4	Features.....	43
1.5	Intended Use.....	43
1.6	Operating Environment.....	43
Chapter 2	INSTALLATION	44
2.1	Batteries installation.....	44
Chapter 3	DEFAULT MENU SCREEN	44
3.1	Menu screen.....	44
Chapter 4	ECG MEASUREMENTS	45
4.1	Methods of ECG measurement.....	46
4.2	Measuring procedure.....	48
4.2.1	Preparing Phase.....	48
4.2.2	Quick measurement by built-in electrodes.....	49
4.3	Long term measurement by external lead wires.....	49
4.3.1	Chest lead measurement.....	49
4.3.2	Limb lead measurement.....	50
4.4	Data analysis and measurement Result Description.....	51
Chapter 5	WAVEFORM REVIEW	52
5.1	Record list.....	52
5.2	Waveform Review.....	53
Chapter 6	DATA MANAGEMENT	55
6.1	Storage status.....	55
6.2	Delete ID.....	55
6.3	Delete all.....	56
6.4	Upload Data.....	56
Chapter 7	MEASUREMENT OPTION SETTING	56
7.1	Creating new ID.....	57
Chapter 8	SYSTEM SETUP	58
8.1	Sound setting.....	58
8.2	Brightness Setting.....	58
8.3	Time/Date Setting.....	58
8.4	Auto power off.....	59

8.5	Power saving.....	59
8.6	Language.....	59
Chapter 9	HELP	60
Chapter 10	TECHNICAL SPECIFICATIONS.....	60
10.1	ECG measurement.....	60
10.2	Power supply.....	61
10.3	Classification	61
10.4	Display.....	61
10.5	Data Memory.....	61
10.6	Overall Dimension and Weight.....	61
10.7	Additional declaration.....	61
Chapter 11	MAINTENANCE	62
Chapter 12	TROUBLESHOOTING.....	63
Chapter 13	KEY OF SYMBOLS	64
Appendix 1	ADDITIONAL MEASURING METHOD	64
Appendix 2	MEASUREMENT RESULT DESCRIPTION.....	67
Appendix 3	GENERAL KNOWLEDGE OF ECG.....	68

Chapter 1 OVERVIEW

1.1 Appearance

1.  Power: Long time press (about 2 seconds) makes the device power on or off; short time press turns on/off the backlight.
2.  Back: back to upper level of menu.
3. Metal Electrode I
4. Measurement: shortcut button for built-in electrodes measuring, press this button to start measuring.
5.  OK: confirm selection or modification.
6. Navigation key:
 - ◁ Left: move the cursor forwards/to the left, or adjust parameter values.
 - ▷ Right: move the cursor backwards/to the right, or adjust parameter values.
 - ▲ Up: move the cursor upward/forward, or adjust parameter values.
 - ▼ Down: move the cursor downwards /backward, or adjust parameter values.
7. Display screen: display ECG waveforms and data.
8. I/O cover
9. Lanyard hole
10. USB interface: USB data socket.
11. DC input socket
12.  Lead wire socket: for connecting to lead wire.
13. Speaker
14. Metal electrode II and III
15. Battery cover, nameplate

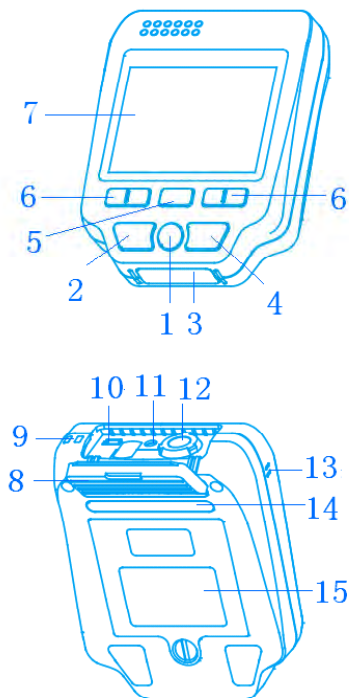

Figure 1.1

1.2 Name and Model

Name: Easy ECG Monitor
 Model: PC-80D

1.3 Structure

PC-80D Easy ECG Monitor mainly consists of circuit boards, display screen and metal electrodes/lead wires.

1.4 Features

1. Small in size, light in weight, and easy to carry.
2. One-key measurement, easy to operate.
3. ECG waveform and interpretation of results are displayed clearly on color dot-matrix LCD screen.
4. UP to 19 types of measurement results can be presented.
5. High capacity of built-in memory, 24 hours records storage and review for single channel waveform; and 8 hours records storage and review for 3 channel waveforms.
6. Quick measurement by built-in metal electrodes, external lead wires (including limb lead and chest lead) for long term measurements are optional.
7. Voice prompt is available
8. With data management function, data records can be reviewed and deleted locally, uploaded to PC as well.
9. Auto power off time can be set.
10. With power saving feature.

1.5 Intended Use

This Easy ECG Monitor is intended for measuring and recording the ECG waveform and average heart rate of adult patient. It is applicable for use in clinics and homes, and convenient to operate by the patients themselves.



This device is not an ECG monitor used in clinical institution or hospital, but is used for spot-check purpose ONLY. It can not be used to substitute the normal ECG examination or real time monitoring. The measurement results are useful reference for doctor, but do not make direct diagnostic or analytical decision based on the information provided by this device.

1.6 Operating Environment

Operating temperature	5°C - 40°C
Operating humidity	30% - 80%
Atmospheric pressure	70 kPa - 106 kPa

Chapter 2 INSTALLATION

2.1 Batteries installation

1. Open the battery cover by a screwdriver or a coin.
2. Insert four AA size batteries directly (as shown in figure 2.1).
3. Close the batter cover and fasten it.

 Do NOT insert batteries with their polarities reversed. Dispose of the used batteries according to applicable local regulations.

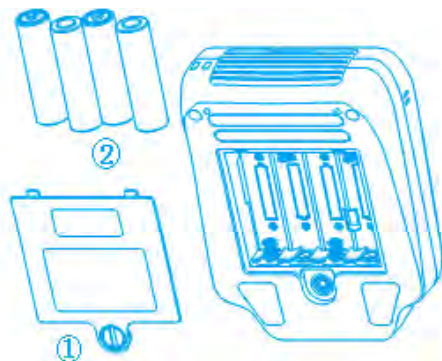



Figure 2.1

Note: Protecting films are attached to the electrodes of device, so please remove the protecting films before measurement.

Chapter 3 DEFAULT MENU SCREEN

3.1 Menu screen

Long time press the “⏻” Power key (lasting for 2 seconds) until a beep sound is heard to indicate the unit is turned on, then the booting screen will appear, as shown in the figure 3.1, after that the device enters into the default menu screen, as shown in figure 3.2. There are 6 entries, press navigation key to shift focus on them and press “■” ok key to go into the selected entry. Each entry has an icon and it is defined as following:

 **Measure:** detect ECG signal, mean while, display waveform, HR value, and analyze the ECG waveform to prompt necessary information.

 **Review:** recall and view the ECG records stored in this device (including waveform data and measurement result).

 **Memory:** ECG records management including storage status check and record deletion.



Version 1.10

Figure 3.1



Option: measurement related setup including signal input selection, measuring time, bandwidth, HR alarm limit setting and user ID (ID number).



Setup: system setup including date/time, language, sound and display etc.



Help: provide on-line information about measuring methods and general knowledge of ECG

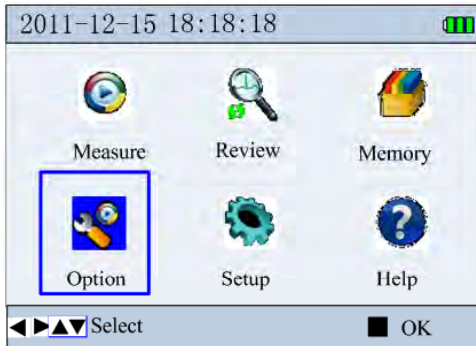





Figure 3.2

Chapter 4

ECG MEASUREMENTS

There are 2 measuring modes for the ECG measurement, which includes quick measurement by built-in electrodes and long term measurement by external lead wires.

- **Quick measurement:** press “” measure key to enter into the quick measurement directly; it can display single channel ECG signal measured by built-in electrodes, the signal can be lead I, lead II or chest lead according to the electrode placement. This measurement takes 30 seconds.
- **Long term measurement:** after selecting the signal input option in the measuring option menu, move the cursor to the “” measure icon, then press the “” ok key to start the long term measurement.

For long term measurement, the external lead wires will be used in stead of built-in electrodes; there are two options for signal input.

1. Limb lead measurement: it measures 3 channels ECG signal for lead I, lead II, and lead III simultaneously and displays them;
2. Chest lead measurement: it measures single channel ECG signal with different chest lead according to the electrode placement. It is suitable for long term measurement.

4.1 Methods of ECG measurement

It is recommended to clean your skin with SOAP and water to keep it moist without oily.

Measurement by built-in electrodes:

Easy and quick ECG measurement by built-in electrodes can be done by putting electrodes on hand, leg and chest respectively.

• Hand measurement

It is convenient to take ECG measurement by hands or palms. The ECG waveform detected by this method is equivalent to Lead I of regular ECG examination.

A) **Palm placement:** Hold the device with right hand; make sure that the fingers touch the metal electrode II and III reliably. Press the electrode I on the left palm, as shown in figure 4.1.

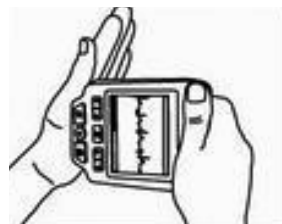

Figure 4.1
Palm placement

B) **Wrist placement:** Hold the device with right hand; make sure that the fingers touch the metal electrode II and III reliably. Press the electrode I below the left wrist about 1 inch, as shown in figure 4.2. When the ECG signal at palm placement is not good, try to measure with wrist placement.



Figure 4.2
Wrist placement

Note: Keep at ease and make sure the skin contact well with the electrodes during ECG measurement. Please place the device on correct position, do not shake it during the measurement. Dirty skin may cause poor signal quality, so clean your skin before measuring.

• Leg Measurement

The ECG waveform detected by Leg Measurement is equivalent to Lead II of regular ECG examination. Keep at ease when seating down, and then lift your left leg on a bench. Hold the device with the right hand when measuring and make sure that the fingers touch the metal electrode II and III reliably, place the electrode I on the left leg above the ankle, as shown in figure 4.3.



Figure 4.3
Leg measurement

Note: Keep at ease and make sure the skin is clean and moist before measuring.

• Chest Measurement

It is recommended to take ECG measurement on chest, since the signal detected by this way is stronger and with less interference.

The ECG waveform detected by Chest Measurement is similar to the Lead V4 or V5 of regular ECG examination. Hold the device with the right hand, make sure that the fingers touch the metal electrode II and III reliably, as shown in figure 4.4, place the electrode I on the left chest align with the midclavicular line (V4 position) or the anterior axillary line (V5 position) and on the level of the 5th intercostal space.



Figure 4.4
Chest measurement

Note: keep at ease and clean the electrode I by using the wet cloth before measuring. If the waveform baseline wanders or noisy waveform appears, hold your breath for a moment to get stable and clean signal.

Measurement by external lead wires

The ECG signal which is detected by external lead wires is more stable than that by hand measurement. ECG measurement by external lead wires can be done by placing the electrodes on limbs or chest respectively.

• Electrodes placement on limbs

On default menu screen enter “” option setup menu to select “limb lead” for signal input. By this way, the 3 channels of limb lead I, II and III can be measured and displayed simultaneously and continuously.

Either adhesive electrodes or limb clip type electrodes (optional) can be used to do the measurement.

The location of the electrodes is shown in figure 4.5.

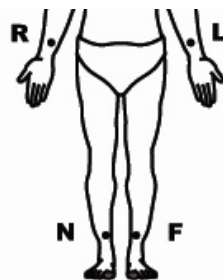



Figure 4.5
The location of electrodes on limbs

R (red): place on interior of right arm
(between the wrist and the elbow);

L (yellow): place on interior of the left arm
(between the wrist and the elbow);

F (green): place on interior of the left leg (between the knee and the ankle);

N (black): place on interior of the right leg (between the knee and the ankle)

Operation: Connecting the lead wires after placing the electrodes well and then insert the connector onto the device; Power on the device to select the “limb lead” for signal input and set the measuring time on option setup menu, then press “” ok key to start the measurement.

Note: keep at ease when seating or lying down. Clean the skin by using the wet cloth when selecting limb clip type electrodes (optional) to measure. Direction of using disposable ECG electrodes: Tearing off the protective film to place it on the skin, and then connecting the electrodes with lead wires. It is recommended to put the electrodes on chest for longtime monitoring, please refer appendix 1 for more details.

• Electrodes placement for Chest Lead Measurement

On default menu screen enter “” option setup menu to select “chest lead” for signal input. ECG signal detected by this method is single channel measurement, which is equivalent to the waveform of regular chest lead. It is intended for professional use (ie. by doctor). The location of the electrodes is shown in figure 4.6.

- R (red): place on interior of right arm (between the wrist and the elbow);
- L (yellow): place on interior of the left arm (between the wrist and the elbow);
- F (green): on the 5th intercostal space at the left anterior axillary line;
- N (black): unused.

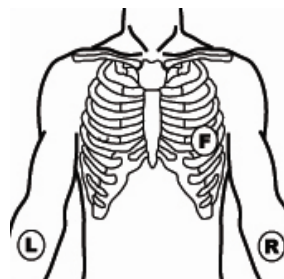



Figure 4.6
The location of chest lead measurement

Operation: Connecting the lead wires after placing the electrodes well and then insert the connector onto the device; Power on the device to select the “chest lead” for signal input and to set the measuring time on option setup menu, then press “” ok key to start the measurement.

Note:

1. The Chest Lead Measurement can obtain the ECG signal of Chest Lead (V1-V6). Please refer to appendix I to select the location of F (green) electrode when you want to get the different chest lead. At the same time, you should set the lead information (V1-V6) that you want on the option setup menu.
2. Either adhesive electrode or sucking bulb electrode (optional) can be used to Chest Lead Measurement. Please refer to appendix I for more details about measuring methods.

4.2 Measuring procedure

4.2.1 Preparing Phase

The quick measurement is as following for details:

At default menu screen, press “” measure key to enter into the quick measuring screen directly, as shown in figure 4.7, in addition, at the

beginning of measurement (including quick and long term measurement), the preparing phase shows on the screen with a heart beat icon and counting down seconds, the beeper will sound with the counting down at the interval of one second.

During this period the device will check the signal quality and auto scale the display. Please adjust your holding position if the detected waveform is not smooth or poor signal and it may prompt: "Check well-connection with lead wires."



Figure 4.7
Quick measurement

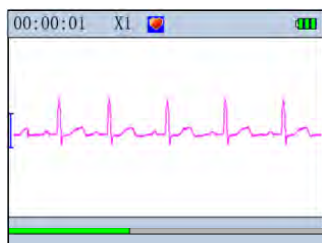

Figure 4.8
Quick measurement



Figure 4.9
Measuring (chest lead)

4.2.2 Quick measurement by built-in electrodes

Please refer to the section 4.1 "Hand measurement" to make the electrodes well-connection with skin. At default menu screen, press "▶" measure key can enter into quick measurement preparing screen directly, after 10 seconds, it will enter into the measuring screen, as shown in Figure 4.8. The measuring time lasts for about 30 seconds.



4.3 Long term measurement by external lead wires

There are 2 options (limb lead and chest lead) for long term measurement by external electrodes. The detail information about the electrodes placement is described in section 4.1.







4.3.1 Chest lead measurement

Please refer to the section 4.1 "Chest lead measurement" to connect the lead wires; enter "👤" option setup menu to select "chest lead" for signal input; return to default menu screen, move the cursor to the "🎯" measure icon, press the "■" ok key to enter into external electrodes measurement (3 lead wires) preparing screen, after 10 seconds, it will enter into the chest lead measuring screen, as shown in Figure 4.9. In this measuring mode, it can measure and display the ECG signal of lead I, lead II, lead III or chest lead (V4) respectively according to electrodes placement.

4.3.2 Limb lead measurement

Please refer to the section 4.1 “Chest lead measurement” to connect the lead wires; enter “” option setup menu to select “limb lead” for signal input; return to default menu screen, move the cursor to the “” icon, press the “” ok key to enter into external electrodes measurement (4 lead wires) preparing screen. After 10 seconds, it will enter into the limb lead measuring screen, as shown in Figure 4.10.

On-screen display:

1. “00: 00: 01” : Measuring time
2. “X1” : “X1” : ECG waveform amplitude scale; “X2” : twice size of the nominal scale; “X4” : four times size of the nominal scale.
3. “” : Heart beat indicator. It flashes while heart beats.
4. “HR=65” : Current HR value.
It is displayed during measurement only when external lead wires are used, if the ECG signal is poor, this value could become “---”.
5.  : Enhanced filter mode indication.
It shows up only when the bandwidth is set to enhanced mode.
6. “” : Status of battery capacity
7. “” : ECG waveform
8. “” : Mark corresponding to 1mV amplitude
9. “” : Status bar of measurement progress.

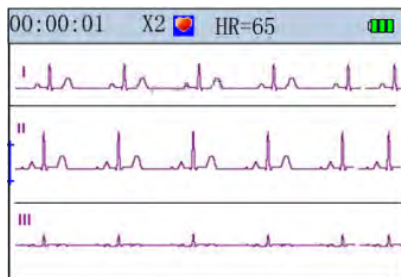







Figure 4.10
Measuring (limb lead)

Operation:

When in the quick measurement by built-in electrodes:

- Press “” key, the measuring display screen will be made a quarter turn counterclockwise;
- Press the “” ok key or “” return key to stop measuring and return to the default menu screen directly, the measuring data won’t be saved.

When in the external electrodes lead wire measurement:

- The device will stop measuring automatically if the measuring time is over;
- Press the “” ok key or “” return key to stop measuring and return to the default menu screen directly, the measuring data would be saved.

Note:

- If the storage is full, the device will stop to measure and it prompts “Fail to save this record because of full data memory”, at this moment, you should delete some records to make sure enough storage space, then measuring again.
- If the battery is low, the battery icon “” flashes red, the device stop to measure and it prompts “low battery voltage, measuring is interrupted,

return key to exit! ”, at this time, connect to external power can continue to measure, or exchanging a new battery to measure again.

- During measuring mode, it will have regular pulse beep sound.
- During the measurement by external lead wires, if “HR alarm” option is set to “On” and the HR value is out of the alarm limits, the alarm sounds will occur with 3 short beeps, and the HR value is reversely displayed.
- During the quick measurement, if the device does not check well contact with the electrodes or the signal is poor, it will not be calculate the average HR value, the measuring result is “poor signal, measure again”, this data will not be saved.
- During the measurement, if the placement of electrodes loose contact with the electrodes, it will prompt “poor signal”. If it is external lead wire measurement, the HR value shows “_”.

4.4 Data analysis and measurement Result Description

When the measuring is finished, the device will analyze the measurement result, as shown in figure 4.11/4.12/4.13; the measurement result description refers to the index 2.

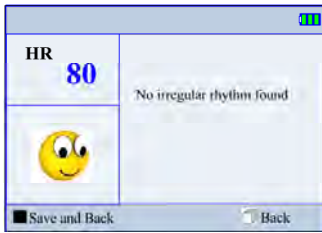

Figure 4.11
No irregularity found
Quick measurement

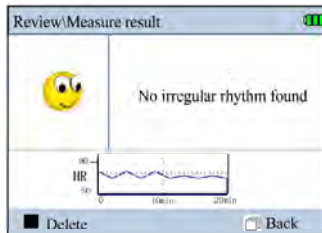

Figure 4.12
No irregularity found in Ext.

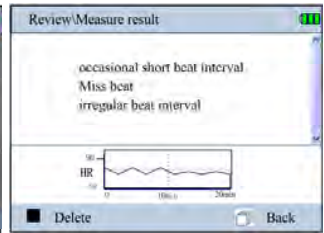

Figure 4.13
Irregularity found in Ext.

1. In the external lead wire measuring mode, the current measurement result will be saved acquiescently, as shown in figure 4.12/4.13. Press the “■” ok key or “⏪” back to return the default menu screen after reviewing the result.
2. After the quick measurement by built-in electrodes, the device will be saved the result automatically, and it prompts “The result is saved successfully, as shown in figure 4.14. Press the “■” ok key or “⏪” back to return the default menu screen. If without any key operation in 6 seconds, press “⏪” back key, return to default menu screen directly and the current measurement result won’t be saved.



Figure 4.14

Notes:

1. Voice prompts for working status and measuring result.
2. The device can provide with 19 types ECG measurement result display when using the quick measurement, the measurement result descriptions refer to the appendix 2 for detail.
3. Up to 8 hours records can be stored in built-in memory, when the memory is full, the device will prompt that “Memory full”.
4. During the external lead wire measurement, the measurement result screen will not be displayed if you press to stop measuring.

Chapter 5 WAVEFORM REVIEW

5.1 Record list

Select “” review key on the default menu screen, then press “” ok key to enter into the user ID list screen, as shown in Figure 5.1. Selecting a folder which contains the data for a given ID, then press OK key, the display screen is as shown in Figure 5.2.



Figure 5.1
Waveform review/ID list



Figure 5.2
Waveform review/record list



Figure 5.3
Quick measurement

Legend of icons:





- : Indicates the measured result without irregularity found.
- : Indicates the measured result with irregularity found.
- : Indicates that the waveform with much interference or lead off during measurement.
- : Indicates the Limb measurement by external electrodes (With 4 lead wires)
- : Indicates the Chest lead measurement by external electrodes (With 3 lead wires)
- : Indicates the quick measurement (by built-in electrodes)

Note: the ID list only display the ID which contains data.



5.2 Waveform Review

In the record list, selecting a record, then press “**■**” ok key, the quick measurement record is shown in the figure 5.3; the external lead wire measuring records is shown in figure 5.4.

On-screen display:

- 1 “”: Measured ECG waveform
- 2 “”: Mark corresponding to 1mV amplitude
- 3 “”: ECG waveform snap-shot
- 4 “”: Zooming box for ECG waveform
- 5 “”: Mark of irregular segment of waveform.
Please refer to appendix 2 for detailed information.

Notes: The Zooming box contains ECG waveform measured in about 3~4 seconds.

- For quick measurement by built-in electrodes, the display will review this record automatically, press “**■**” ok key, the display will browse the recorded waveform automatically, Press it again to stop the browsing operation; Press the “/” can scroll the waveform manually. When the review is finished, press “**■**” ok key to bring the measurement result, as shown in figure 5.5, in the measuring result screen, press “**■**” ok key, it prompts “Are you sure to delete this record?”, as shown in figure 5.6 screen. You can delete this record according the prompts.
- For external lead wires measurement (limb lead and chest lead), the display shows 5 lines of compressed waveform, every line contains 30 seconds of waveform data as shown in figure 5.4. Press the “/” key to move the grey zooming box pane, press “**■**” ok key to zoom in the waveform display within the grey zooming box.

The chest lead review screen is shown in figure 5.7; the limb lead review screen is shown in figure 5.8.



Figure 5.4
Review (External electrodes)

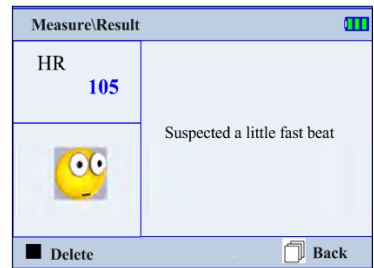

Figure 5.5

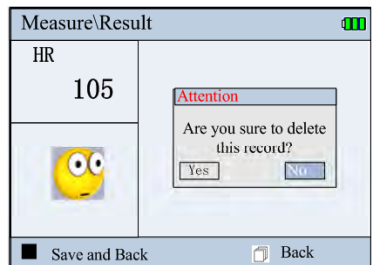

Figure 5.6

In the figure 5.7/5.8/5.9 screen, press the “■” ok key can review the result description for this ID record, as shown in figure 5.10/5.11. In the measure result screen, press the “■” ok key can delete this record.

Note:

- When in limb lead review screen, press “▲, ▼” key can switch the three and single signal channel on screen display; and if there is any irregular found in the review screen, it will display the measuring HR value instantaneously, and there is an inverted triangle shown on the irregular segment, as shown in figure 5.9.
- For the external lead wire measurement record description, if there is no irregular found, it will display a smile face and prompts “No irregularity found”. HR trend graph which shown below displays the HR record in length of 20 minutes in one page, press “◀, ▶” to review next page, as shown in figure 5.10; if there is any irregularity found, the result is as shown in the figure 5.11, it will display the statistical result of irregularity.



Figure 5.7
The Chest lead

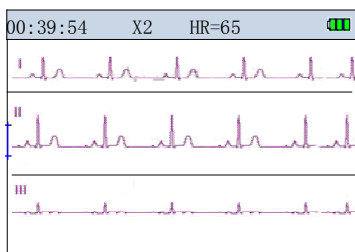

Figure 5.8
No irregular found in Limb lead

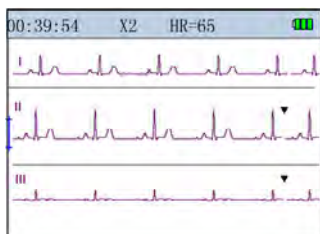

Figure 5.9
Irregular found in Limb lead

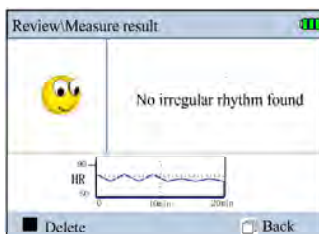

Figure 5.10
No irregularity found (Ext.)

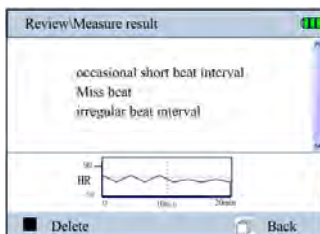

Figure 5.11
Irregularity found in Ext.

Chapter 6

Data Management

Select “Memory” icon on the default menu, then press “■ OK” button to enter into data management screen, as shown in Figure 6.1.

6.1 Storage status

On data management screen, select “Statistic”, then press “■ ” ok key to enter into the Storage status screen, as shown in Figure 6.2.

6.2 Delete ID

- On data management screen, select “Delete” with Navigation Key, then press “■” ok key to enter into the ID list screen, as shown in figure 6.3.
- Press the Navigation Key “◀, ▶, ▲ or ▼” to select the ID; when pressing “■” ok key, there are two different prompts for two different situations:
 - Situation 1:** this ID does not contain any data record.
 - The ID number of “00000” ~ “00004” is reserved, when pressing “■” ok key, the device prompts “This ID can’t be removed”.
 - If it is a new ID, press the “■” ok key to delete the selected the record according to the prompt: “Are you sure to delete this ID”.
 - Situation 2:** there are data records under this ID. Pressing “■” ok key to enter into the record list screen, as shown in figure 6.4. The record list screen display the date and time of all records for this ID.

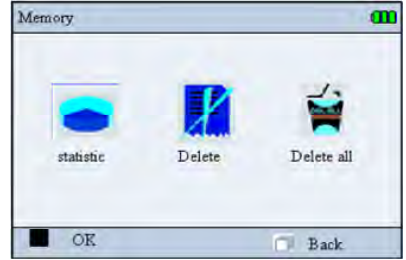

Figure 6.1

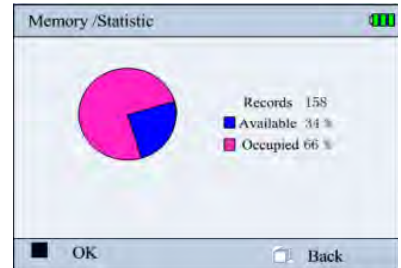

Figure 6.2



Figure 6.3



Figure 6.4

Press the Navigation Key “◀” key to perform select this ID (press it again to cancel selection), the selected record will be labeled “√”; Press the Navigation Key “▶” key to select all the data records under this ID (press it again to cancel selection), the selected record will be labeled “√”; Press “■” ok key: delete the selected record according to the prompt.

Note: the ID list display the all ID numbers, even if there is no record under this ID number.

6.3 Delete all

On data management screen, select “Delete all” with Navigation Key, then press “■” ok key, at this time it prompts that “Delete all”. You can delete all data records stored in the device according to the prompt.

6.4 Upload Data

When measuring is finished, on data management screen, select “Upload data” to enter into upload data screen, as shown in figure 6.5. On this screen, you can transmit data to PC for data management, and interpretation through PC-80D data cable. Please refer to the ECG Viewer Manager for detailed operation.

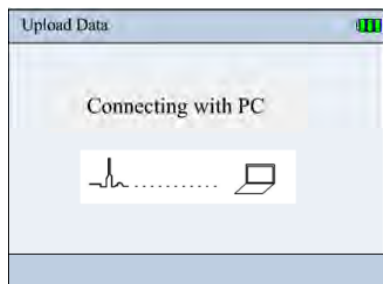

Figure 6.5

Chapter 7 Measurement option setting

On the default menu, select the “Option”, then press the “■” ok key to enter into the optional parameters setting for measurement, as shown in figure 7.1.

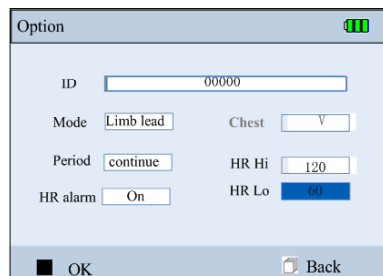

Figure 7.1

On-screen display:

- **User ID:** Displaying the established ID No. or “New ID”. At most 100 ID can be created. When creating a new ID, at most 30 characters can be entered; the default ID is “00000”, the number of “00000” ~ “00004” is reserved (already created at factory) and can not be deleted.
- **Mode:** it is valid only for external lead wires. “Limb lead” and “Chest lead” are optional. The “Limb lead” is external electrodes measurement with 4

lead wires; the “Chest lead” is the external electrodes measurement with 3 lead wires, it is intended for professional use (ie. by doctor). The “limb lead” or quick measurement by built-in electrodes is recommended for normal use. The default setting is “limb lead”.

- **Chest lead:** when the measuring mode is set to “chest lead”, V lead is defaulted setting. If you want to obtain specific Chest Lead (V1-V6), select the lead name (V1-V6) from the pull-down menu.
- **Period:** “30S”, “1min”, “5min”, “10min”, “30min”, “continuous” are optional. The default measuring time is “continuous”.
- **HR alarm:** “On “and “Off “are optional. The default setting is “On”.
- **HR Hi/Lo:** 35~240bpm, the default value is 120bpm; the low alarm limit setting range: 30~235bpm, the default value is 60 bpm.

Operation:

1. Press the navigation key “◀/▶, ▼ or ▲”: Move the cursor upwards/backwards.
2. Press “■” ok key: Conform to option and enter into the corresponding parameter setting.
3. Press the navigation key “▼ or ▲”: Adjust parameter values.
4. Press “■” ok key: Conform the selection, if you do not want to adjust parameter values, or the setting is accomplished please enter the “🗑 Back” button.

7.1 Creating new ID

On the “Option” setup menu, selecting “New ID” item from the ID pull-down menu, as shown in figure 7.2.

Operation:

1. Press the navigation key “◀/▶, ▼ or ▲”: Move the cursor upwards/backwards.
2. Press the “■”ok key: Conform to select the corresponding numbers or letters.
3. Press the navigation key “◀/▶, ▼ or ▲”: Move the cursor to “Enter” key, press the OK key “■” to accomplish the operation.

During entering the ID number, you can move the cursor to the “Del” button to correct the numbers or letters input error. When the entering number exceeds 30 characters, the cursor would move to the “Enter” button to prompt the user that the entering is finished.

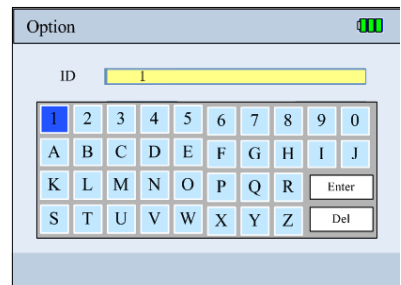

Figure 7.2

Chapter 8

SYSTEM SETUP

On the default menu screen, select “Setting” with Navigation Key, then press “■” ok key button to enter into system setup screen, as shown in Figure 8.1.

1. Press the navigation key “</>”, ▼ or ▲: Move the cursor upwards/backwards.
2. Press “■” ok key Conform to option and enter into the corresponding parameter setting.
3. Press the navigation key “</>”, ▼ or ▲: Adjust parameter values.
4. Press “■” ok key: Conform to option, if you do not want to adjust parameter values, or the setting is accomplished please enter the “☐” Back” button.

8.1 Sound setting

On system setting screen, select “Volume” to enter into the sound setting screen, as shown in figure 8.2.

- **Beep:** Setting the beeper and voice Open/Close. Move the slide icon to left means the beeper is disabled; Move the slide icon to right means the beep is enabled.
- **Speech:** Adjust the volume with the navigation key. Move the slide icon to left means the speech volume is minimal; Move the slide icon to right means the speech volume is maximal.

8.2 Brightness Setting

Brightness setting screen is shown in figure 8.3. Adjust brightness with Navigation Key.

8.3 Time/Date Setting

Date and time setting screen is shown as figure 8.4.

1. press navigation key “</>”, ▼ or ▲”and “■” ok key to select the date and time you need.
2. press navigation key “▼, ▲”to adjust the time value.
3. Press “■” ok key confirm the date and time setting value. If you do not want to adjust the parameter value or the setting is finished, please press the “☐” back button.



Figure 8.1



Figure 8.2

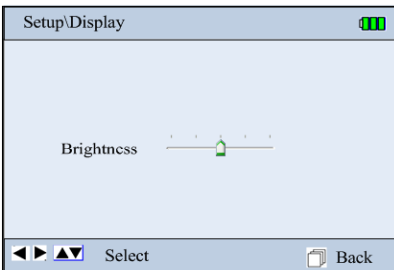

Figure 8.3

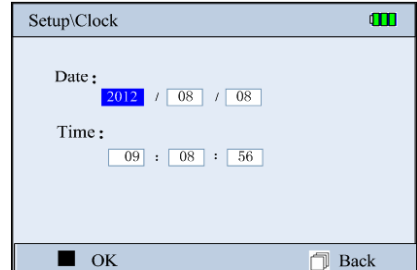

Figure 8.4

8.4 Auto power off

The timeout setting for auto power off is shown in the figure 8.5.

Press navigation key “</>”, ▼ or ▲” to set the timeout time. Press the “☰” back button when setting is done.

8.5 Power saving

The power saving setting screen is shown in figure 8-6.

Press navigation key “</>”, ▼ or ▲” to set the timeout time for power saving. Press the “■” back button when setting is done. The display screen will be dark when the device works in power saving mode.

Exit from power saving mode:

- Press any key to exit from power saving mode.
- Power saving mode terminates automatically when lead off.

8.6 Language

Press navigation key “</>”, ▼ or ▲” in the system setup screen shown in the figure 8.1 to select language icon, press “■”ok key to change the language, as shown in the figure 8.7.

It has “Chinese”, “Traditional Chinese” and “English” language modes.

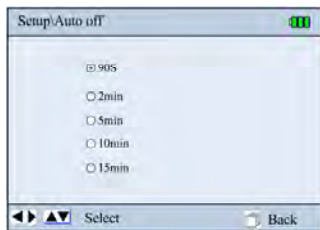

Figure 8.5

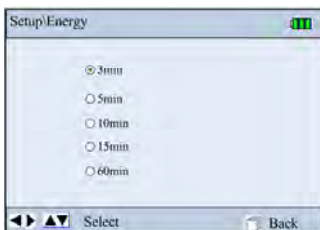

Figure 8.6



Figure 8.7

Chapter 9 HELP

On default menu screen, select “Help”, then press “■” ok key to enter into help info screen. In the info screen, you can browse the “FAQ”, “How to”, “ECG info” and software version information. As shown in 9.1.

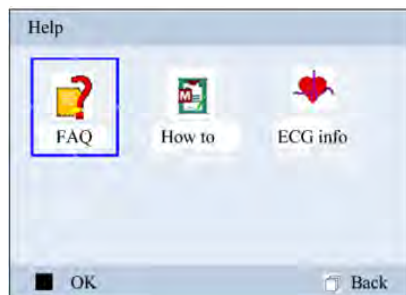

Figure 9.1

Chapter 10 TECHNICAL SPECIFICATIONS

10.1 ECG measurement

1. Amplification channels: 3.
2. Signal input: 3 embedded metal electrodes or external lead wire cable (with 3/4 lead wires).
3. Lead selections and measuring methods: Quick measurement by embedded electrodes; measurement by external electrodes with 3 lead wires (single channel for Lead I, II, or III) or 4 lead wires (3 simultaneous channels for Lead I, II and III)
4. ECG bandwidth: 0.05Hz~40Hz (Enhanced mode), 0.5Hz~40Hz (Normal mode). +0.4dB
-3.0dB
5. Internal noise level: $\leq 30\mu\text{Vp-p}$
6. Heart Rate measuring range: 30bpm~240bpm
7. Heart Rate measuring accuracy: $\pm 2\text{bpm}$ or $\pm 2\%$, whichever is greater
8. Display scale: $5.0\text{mm/mV} \pm 10\%$
9. Common-mode rejection ratio (CMRR): $\geq 60\text{dB}$

10. Waveform sweeping speed: 20mm/s \pm 10%
11. Input loop current: $\leq 0.1 \mu\text{A}$
12. Input impedance $\geq 5 \text{ M}\Omega$ (single ended)
13. Max. input DC offset voltage: $\pm 300\text{mV}$

10.2 Power supply

Battery: 4 \times AA alkaline batteries (or 4 \times AA NiMH rechargeable batteries)

External DC input: 5.0V/1.0A; provided AC adapter input voltage:
a.c. 100~240V, 50/60Hz.

Auto power-off: timeout setting from 90s to 15 minutes

Threshold of low battery voltage indication: 4.4V \pm 0.2V.

10.3 Classification

The type of protection against electric shock:

Internally powered equipment

The degree of protection against electric shock: Type BF applied part

The degree of protection against harmful ingress of liquid:

Ordinary equipment without protection against ingress of liquid.

Electro-magnetic Compatibility: Group I, Class B

10.4 Display

LCD type: Color LCD

Display area: 70.08mm x 52.56mm.

10.5 Data Memory

Stored data records can be uploaded to the computer by data cable provided by the manufacturer.

10.6 Overall Dimension and Weight

Dimension: (L) 130 mm \times (W) 98 mm \times (H) 36 mm

Weight: 400g (not including batteries)

10.7 Additional declaration

1. Electro-surgical interference suppression: Without the function of Electro-surgical interference suppression.
2. Defibrillator discharge protection: Without protection against defibrillator discharge.

3. Respiration or lead off detector and active noise suppressor:
The auxiliary leakage current is less than 0.1uA.
4. Per minutes HR average calculation: the latest 8 times R-R intervals falling on the range of heartbeat average.
5. Display updates speed: 1 time/ second.
6. Battery life: Four AA alkaline batteries can be used for more than 2 hours measurement, or Four AA NiMH rechargeable battery (Capability at least 2200mAH) can be used for more than 8 hours.
7. Maximal input DC offset voltage: $\pm 300\text{mV}$.

Chapter 11

MAINTENANCE

1. Please change the batteries, when appears low-voltage icon.
2. It is recommended to wipe the metal electrode with medical alcohol, when the measuring signal is too weak.
3. Please wipe the surface of the unit with clean cloth or let it dry in air.
4. Please take out the batteries if the unit will not be used for a long time.
5. Storage and Transportation
Ambient temperature: -20 to 60°C
Relative humidity: 10~ 95%
Atmospheric pressure: 50~107.4KPa
6. In case any indication of damage about the function of the monitor, it is not allowed to apply it to the patient for any monitoring. Please contact the local dealer or our company in case of any problems. We are to offer you the best solution for your satisfaction.
7. The maintenance is to extend the life of the electrodes; on the surface of the electrodes you should clean it by wet cloth or medical alcohol if necessary. It is recommended to protect the electrodes from ultraviolet radiation; do not wipe the electrodes with hard and rough things.

Notes:

1. Keep it away from corrosive substances, explosive substances, high/low temperature and moisture.
2. If the device gets wet or has water steam, please stop operating it.
3. When it is taken from cold environment to warm and humid environment, please do not use it immediately.
4. DO NOT operate the button on front panel with sharp materials.
5. DO NOT immerge the device into liquid. Do NOT spray any liquid on it directly.
6. The life of this unit is 5 years. In order to ensure its long service life, please pay attention to the use of maintenance.

Chapter 12

TROUBLESHOOTING

The device can not turn on.

Possible Reason	Solution
1. The batteries are drained or almost drained.	1. Change batteries.
2. The batteries are not inserted properly.	2. Reinstall batteries.
3. The device is broken out.	3. Please contact the local service center.

The device is failure in measuring heart rate.











Possible Reason	Solution
1. Electrode and body does not contact well.	1. Place the electrode correctly.
2. Moved when measuring.	2. When measuring, please keep quiet and avoid moving.
3. Electromagnetic interference.	3. Keep away from interference source.
4. Weak signal.	4. Change a place (chest) to measure.

ECG waveform excursion, strong irrelevant waveform or the ECG waveform displays on the screen, but the prompt info is "Contact?".

Possible Reason	Solution
1. Skin is dry or oily.	1. Clean skin with soap and water and eliminate skin crumb and grease to make the skin wet and greaseless.
2. Electrode and body does not contact tightly	2. Press the electrode with a certain force.
3. Muscle strain.	3. Keep hand relax while measuring.

Chapter 13

KEY OF SYMBOLS

Symbol	Description	Symbol	Description
	Battery indicator		Heart Rate (Unit: beats per minutes)
	Power button		shortcut button for ECG measuring
	Confirmation button		Back button
	Navigation key		USB Port
	Lead wire socket		Type BF
NS	Serial number		DC power supply port

Appendix 1

ADDITIONAL MEASURING METHOD

- Direction of using limb clip type electrodes: clean the electrodes by using wet cloth; plug the lead wires into socket; or affix the lead wires to clip, and then keep the clip in measuring position.
- Direction of using sucking bulb electrode: Squeeze the rubber bulb with your hand to make the metal dish place on the measuring position.

1. Limb lead measurement (paste on chest)

This measurement applies to long term measurement for ECG signal of limb lead I, II, or III. The electrodes are adhesive ECG electrodes.

The location of the electrodes:
(as shown in figure 1)

R: below the clavicle and close to right shoulder;

L: below the clavicle and close to left shoulder;

N: on the right lower abdomen;

F: on the left lower abdomen.

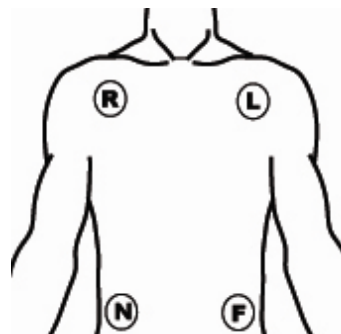

Figure 1
Limb lead (paste on chest)

2. Chest lead measurement (paste on chest)

R (red): below the clavicle and close to left shoulder;

L (yellow): below the clavicle and close to right shoulder;

F (green): on chest, please refer to the figure 4 (location of V1-V6 is optional).

N (black): unused.

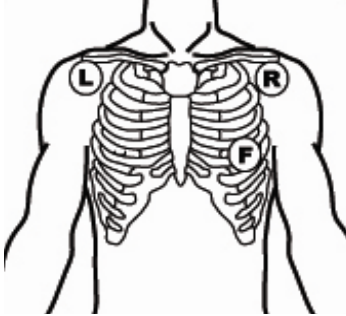

Figure 2
Chest lead (paste on chest)

3. Chest lead measurement (limb clip type electrodes + sucking bulb electrode)

R (red): place on interior of left arm (between wrist and elbow),

L (yellow): place on interior of the right arm (between wrist and elbow);

F sucking bulb electrode (green): on chest, please refer to the figure 4.1 (location of V1-V6 is optional),

N (black): unused.

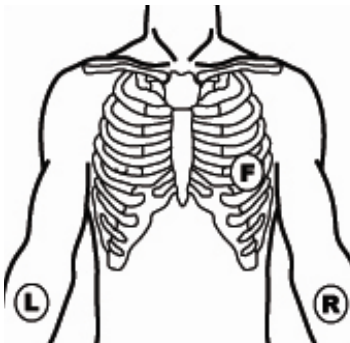

Figure 3 - Chest lead
(limb clip type electrodes +
sucking bulb electrode)

4. F green electrode location of Chest lead measurement

The location of ECG electrodes: electrode location for V1-V6		
on the 4th intercostal space at right border of sternum		V1
on the 4th intercostal space at left border of sternum		V2
midway between the V2 and V4		V3
on the 5th intercostal space at the left midclavicular line		V4
on the left anterior axillary line at the horizontal level of V4		V5
on the left midaxillary line at the horizontal level of V4		V6

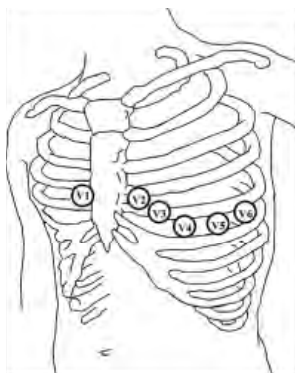

Figure 4
F electrode location of chest lead

Appendix 2

MEASUREMENT RESULT DESCRIPTION

No.	ECG Measurement Result Descriptions	Notes: (bpm: time/minute)
1	No irregularity found.	$60 \text{ bpm} \leq \text{HR} \leq 100 \text{ bpm}$, No irregular HR found
2	Suspected a little fast beat	$100 \text{ bpm} < \text{HR} \leq 110 \text{ bpm}$
3	Suspected fast beat	$\text{HR} > 110 \text{ bpm}$
4	Suspected missing Beat	No heart beat is detected within the period of twice of average R-R interval
5	Suspected arrest	No heartbeat is detected within 4 seconds
6	Suspected short run of fast beat	More than 3 consecutive premature beats are found
7	Suspected a little slow beat	$50 \text{ bpm} \leq \text{HR} < 60 \text{ bpm}$
8	Suspected slow beat	$\text{HR} < 50 \text{ bpm}$
9	Suspected occasional short beat interval	Premature beat
10	Suspected occasional irregular beat interval	Bigeminy and Trigeminy.
11	Suspected a little fast and interval with occasional short beat interval	A little fast beat and suspected Premature beat.
12	Suspected a little slow and interval with occasional short beat interval	A little slow beat and suspected Premature beat.
13	Suspected a little slow beat and interval with occasional irregular beat	A little slow beat and suspected Bigeminy / Trigeminy.
14	Waveform baseline wander	Signal saturation or lead wire off during measuring, but the average HR still be calculated.
15	Suspected fast beat with baseline wander	Fast beat and interval with waveform baseline wander.
16	Suspected slow beat with baseline wander	A little slow beat and interval with waveform baseline wander.
17	Suspected occasional short beat interval with baseline wander	Premature beat with waveform baseline wander
18	Suspected occasional irregular beat interval with baseline wander	Bigeminy /Trigeminy with baseline wander
19	Poor Signal, measure again	Small waveform or baseline wander is larger, average HR can not be measured.

Appendix 3 GENERAL KNOWLEDGE OF ECG

Normal sinus rhythm:

In sinus conditions, SA node paces the heart with the regularly rate and the normal rhythm. The heart rate is in the range of 60 to 100 times per minute and the rhythm is regular. P wave is normal

and each one is followed by a QRS wave. P-R interval: 0.12~0.20s; QRS wave: 0.06~0.10s; No ectopic ECG activity.

Symptom: Sinus rhythm, heart rate: 60~100bpm

Indication: Normal

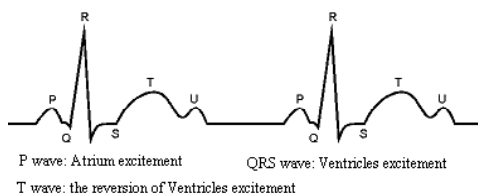

Figure 1
Normal ECG Waveform

Several abnormal ECG waveforms

- **Tachycardia:** The heartbeat becomes faster. Tachycardia is determined by the rhythm of the heart, the average rhythm beats faster than 100 times a minute is considered as Tachycardia. The result description “Suspected fast beat” in this device may be doubted as Tachycardia.

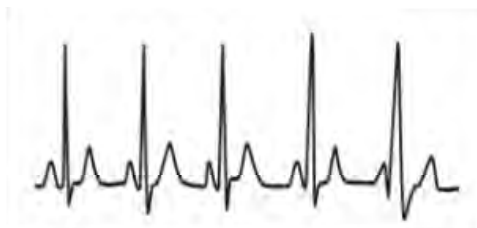

Figure 2
Tachycardia Waveform

Symptom: heart rate>100bpm

Indication: It may occur with the normal people who have these physiology conditions: rage, fatigue, smoking, drinking too much wine, excessive coffee and strong tea, etc.

Pathology: anemia, Hyperthyroidism, blood hypoxia, myocarditis, hypokalemia, fever, influence of some medication (such as atropine, epinephrine etc.).

Suggestion: If it belongs to pathology condition, please go to hospital.

- **Bradycardia:** The heartbeat becomes more slowly. It is determined by the rhythm of the heart, the average rhythm is less than 60 beats per minute is considered as Bradycardia. The result description “Suspected slow beat” in this device may be doubted as Bradycardia.

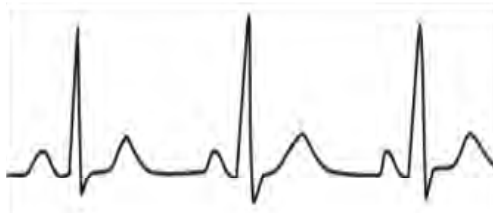

Figure 3
Bradycardia Waveform

Symptom: heart rate < 60 bpm

Indication: It occurs when healthy people fall asleep, and it can be found in athlete (or those who love doing sports frequently), old people, or vagus excitement person.

Pathology: Sick sinus syndrome, Ischemic heart disease, Cardiomyopathy, intracranial hypertension, increased hypokalemia, Low temperature, period of convalescence of acute infectious disease or after use some medicines such as digitalis.

Suggestion: If it belongs to the pathology condition, please see the doctor.

- **Premature beat:** In a normal beat a QRS waveform appears prematurely and is followed by a comeback pause. The result description “Suspected occasional short beat interval” in this device may be doubted as Premature beat.

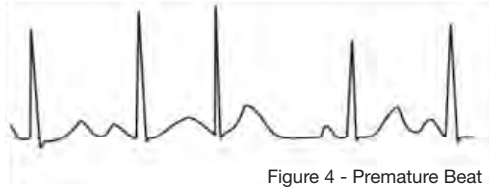

Figure 4 - Premature Beat

What is premature beats? It is premature contraction.

The normal heart beat is always regularly, and each beat interval is also symmetrically; Premature beat is out of this general regulation, the heart beats prematurely and followed by a long time interval; the phenomena of a premature beat between two heart beats is called inserting premature beat. The display of “early beat” may be suspected Premature beat.

According to different original positions it can be divided into Premature Atrial Contraction, Premature Nodal Contraction and Premature Ventricular Contraction (PVC), which needed to be judged by experts.

Symptom: The heart beat is arrhythmic, it occurs as the phenomenon that the heart suddenly beats and then stops for a while. Some people have palpitation or have no symptom.

Indication: The premature beat can be found occasionally in healthy people, with no distinct symptom or sometimes with palpitation. This may be caused by fatigue, anxiety, insomnia, smoking too much, or drinking too much wine, coffee, strong tea etc. It can be recovered without treatment. However, if premature beat occurs frequently, continuously or in multi-focus, it will indicate functional cardiovascular disease.

Please see a doctor as soon as possible.

Suggestion: The character of premature beat needs professional to confirm, so please save the temporal figure in time. When seeing a doctor, you can recall it to doctor to judge the character of premature (Premature Atrial Contraction, Premature Nodal Contraction, Premature Ventricular Contraction or multi-focus premature beat) and help cure.

Testee's Symptom: Normal heart beat is followed by a premature beat.

- **Bigeminy:** It is a type of PVC in which a normal beat is coupled with a premature beat. Because of its trigger cardiac abnormal pacemaker in different position, it divided into arial, ventricular and node. In the clinic medically, the ventricular is the most common, aria is more common, but the node is rarely found.

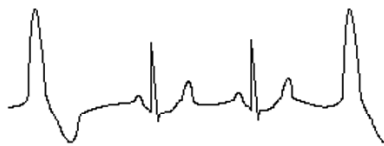

Figure 5 - Bigeminy

Indication: PVC occurs frequently.

Suggestion: Please see the doctor

- **Trigeminy:** It is a type of PVC in which two normal beats are coupled with a premature beat. Because of its trigger cardiac abnormal pacemaker in different position, it divided into Atrial, ventricular and node. If ventricular trigeminy occurs 3 times continuously, please see a doctor as soon as possible.

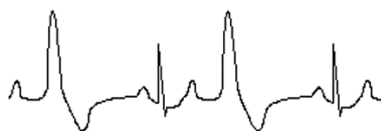

Figure 6 -Trigeminy

Indication: PVC occurs frequently.

Suggestion: Please see the doctor.

- **Short run of tachycardia:** PVC (Premature Ventricular Contraction) occurs more than 3 times continuously.

Testee's Symptom: PVC occurs More than 3 times continuously.

The heart beat is fast and regularly, but starts and stops suddenly.

According to the different of active original position, it can be divided into: Paroxysmal ventricular tachycardia, Paroxysmal supraventricular tachycardia (Needing professional to judge).

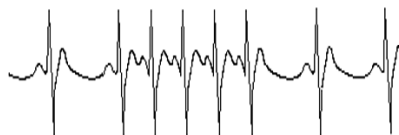

Figure 7 - Tachycardia

- 1) **Paroxysmal supraventricular tachycardia:** By atrial and nodal extrasystole cause to happen, frequency >180Dpm (time/minute).

Indication: Most commonly found in healthy people, it causes by deep respiration, tachypnea, positional changes, swallow, rage etc.

It also appears in functional cardiac disease such as Wolff - Parkinson - White Syndrome, rheumatic heart disease, coronary heart disease, Cardiomyopathy, Congenital heart disease, medicinal reaction (digitalis toxicosis) etc.

Suggestion: If it occurs time after time, please see the doctor as soon as possible.

2) Paroxysmal ventricular tachycardia: Caused by Premature Ventricular Contraction, Heart Rate >140bpm.

Indication: Most commonly found in heart disease patient, it can cause ventricle fibrillation if it's serious, so the tester needs to see a doctor immediately.

Suggestion: The character of short run needs professional to confirm, so please save the temporal figure in time. And you can provide it to doctor as a reference.



Disposal: *The product must not be disposed of along with other domestic waste. The users must dispose of this equipment by bringing it to a specific recycling point for electric and electronic equipment. For further information on recycling points contact the local authorities, the local recycling center or the shop where the product was purchased. If the equipment is not disposed of correctly, fines or penalties may be applied in accordance with the national legislation and regulations.*

GIMA WARRANTY CONDITIONS

Congratulations for purchasing a GIMA product. This product meets high qualitative standards both as regards the material and the production. The warranty is valid for 12 months from the date of supply of GIMA. During the period of validity of the warranty, GIMA will repair and/or replace free of charge all the defected parts due to production reasons. Labor costs and personnel traveling expenses and packaging not included. All components subject to wear are not included in the warranty. The repair or replacement performed during the warranty period shall not extend the warranty. The warranty is void in the following cases: repairs performed by unauthorized personnel or with non-original spare parts, defects caused by negligence or incorrect use. GIMA cannot be held responsible for malfunctioning on electronic devices or software due to outside agents such as: voltage changes, electro-magnetic elds, radio interferences, etc. The warranty is void if the above regulations are not observed and if the serial code (if available) has been removed, cancelled or changed.

The defected products must be returned only to the dealer the product was purchased from. Products sent to GIMA will be rejected.