

# DIATERMO

## MB 120 F / MB 200 F

MONOPOLAR AND BIPOLAR FLASH ELECTROSURGICAL UNIT



DIATERMO MB 200 F



### GIMA SPA

Via Marconi 1 - 20060 Gessate (MI) - ITALY  
Tel +39 02 9538541 Fax +39 02 95381167  
www.gimaitaly.com  
gima@gimaitaly.com - export@gimaitaly.com

MA396\_GB

CE  
0051

Instruction's Manual  
ENGLISH



**Summary**

IMPORTANT	3
INTRODUCTION	4
Destination of Use / Sectors of Application	4
Standard and Optional Composition	4
General Description	5
ELECTROPHYSICAL PRINCIPLES	6
OPERATIVE TECHNICS	7
Monopolar Cut	7
Monopolar Coagulation	7
Bipolar Coagulation	8
CONTRAINDICATIONS AND COLLATERAL EFFECTS	8
SAFETY	8
General	9
Installation	10
HF Electrosurgical in Laparoscopy	11
INSTALLATION	11
CONNECTOR AND CONTROLS	14
Label on the Rear Panel	14
Manufacturer's Identification Data	14
Technical Data	14
Meaning of Graphics Symbols	14
Frontal Pannel	15
Operation Mode	15
Switch On	15
Neutral Electrode's Circuit (Skin Plate Electronic Control)	15
Repetition interval of the impulses and presetting of the supply time	16
Memorization of the directions for use	16
Monopolar	16
Current for Cut (CUT)	17
Corrente Misclata (BLEND)	17
Current for Enhanced Cut (ENHANCED CUT)	17
Current for Superficial Coagulation (FORCED COAG)	17
Current for Deep Coagulation (SOFT COAG)	17
Bipolar	18
Current for Bipolar Coagulation (BIPOLAR COAG)	18
Autostart and Autostop	18
Signaling of Excessive Time of Delivery	19
Signaling of Excessive Impedance in the Circuit of Neutral Electrode (OC)	19
Adjustment of the Acoustic Signal Level	19
Automatic Control of the Internal Parameters	19
Connectors	19
Back Panel	20
Power Supply Module and Voltage Selector	20
Power On-Off Switch	20
TECHNICAL CHARACTERISTICS	21
MAINTENANCE	22
General	22
Cleaning of the Cabinet	22

Cleaning and Sterilization of the Accessories Items -----	22
Guide to the Solution of the Problems-----	22
Repairs-----	22
Fuses Substitution-----	22
Checking of the Equipment Before Each Use-----	23
Function and Safety Check and Test -----	23
DIAGRAMS -----	24

## **IMPORTANT**

These operating instructions form an integral part of the equipment and must be available to the operating personnel at all times.

All the safety instructions and advice notes are to be observed. Be sure that these operating instructions are furnished together with the equipment when this is transferred to other operating people.

In case of necessity of technical, or other type, assistance contact your own retailer.

*Produttore / Manufacturer*

**LED SpA**

*PROGETTAZIONI E PRODUZIONI ELETTRONICHE*  
Via Selciatella, 40 04011 APRILIA (LT) ITALIA



---

**MA396A\_GB**

*Edition 02.2011*

2011 © LED SpA

---

*No part of this document could be photocopied, reproduced or translated in other language without the written consent of LED SpA. All rights reserved.*

## INTRODUCTION

### Destination of Use / Sectors of Application

The use of HF electro surgical equipments **DIATERMO MB 120 F** and **DIATERMO MB 200 F** has reserved to specialized medical personnel. The equipment has destined to a temporary use, for surgical operations in emergency room or hospital. It has foreseen its use in the monopolar cut, cut coagulated or coagulation mode or in bipolar coagulation mode.

The equipment is conceived for being used in the following sectors:

Description	DIATERMO	
	MB 120 F	MB 200 F
Electrosurgical unit code	GMA10300.101	GMA10300.401
Causalty	○	○
Dental	○	—
Dermatology	●	○
Endoscopy	○	○
First Aid	●	●
Gastroenterology	○	●
General Surgery	—	●
Gynecology	○	●
Neurosurgery	—	●
Ophthalmic	○	○
Orthopedics	—	○
Otorhinolaryngology	○	●
Pediatric Surgery	—	○
Plastic Surgery	—	○
Pneumology	—	●
Urology	—	●
Vascular Surgery	●	●
Veterenary	○	○

● = Recommended      ○ = Usable      — = Not Recommended / Not Usable

### Standard and Optional Composition

Code	Description	DIATERMO	
		MB 120 F	MB 200 F
-	Electrosurgical unit code	GMA10300.101A	GMA10300.401A
F4243	Reusable handle with finger switches (HPSW112)	●/1	●/1
00201.01	Handle for microsurgical needle	●/1	●/1
00500.00	Kit of assorted electrodes(10pcs) 5cm	●/1	●/1
500500.L11	Needles for micro-surgery (10Pcs)	●/1	●/1
152-110	Blade electrode 7 cm	●/3	●/3
152-120	Needle electrode 7 cm	●/3	●/3
152-150	Ball electrode Ø 4mm 6 cm	●/3	●/3
00404.08	Cable for connected neutral electrode disposable type / 5365	●/1	●/1
5365A	Steel neutral electrode 120x160mm	●/1	●/1
F7920	Disposable Split Neutral electrode	●/2	●/2
0350	Disposable Neutral electrode	●/2	●/2
00302.00	Water-proof foot switch	●/1	●/1
00100.01	Power supply cable 5m 3x1.5mm SIEMENS-IEC	●/1	●/1
152-132	Ball curved electrode Ø 2mm 6 cm	○	○
152-142	Ball curved electrode Ø 3mm 5 cm		○
152-152	Ball curved electrode Ø 4mm 6 cm		○
152-162	Ball curved electrode Ø 5mm 6 cm		○
152-130	Ball electrode Ø 2mm 6 cm		○
152-145	Ball electrode Ø 3mm 14 cm		○
152-140	Ball electrode Ø 3mm 6 cm		○
152-165	Ball electrode Ø 5mm 14 cm		○
152-160	Ball electrode Ø 5mm 6 cm		○
500500.L10/L	Bent ball electroØ 3mm (5Pz) 10cm		○
500500.L10	Bent ball electroØ 3mm (5Pz) 5cm		○
500500.L5/L	Bent hook electrode (5Pz) 10cm		○
500500.L5	Bent hook electrode (5Pz) 5cm		○

Code	Description	DIATERMO	
		MB 120 F	MB 200 F
500500.L6/L	Bent thick wire electrode (5Pz) 10cm		○
500500.L6	Bent thick wire electrode (5Pz) 5cm	○	○
500500.L2/L	Bent thin wire electrode (5Pz) 10cm	○	○
500500.L2	Bent thin wire electrode (5Pz) 5cm	○	○
CB462	Bipolar cable 3mt	○	○
310-550	Bipolar electrode 20cm – curved	○	○
310-590	Bipolar electrode 20cm – curved 2	○	○
310-510	Bipolar electrode 20cm – direct	○	○
310-110-05	Bipolar Forceps 11,5cm TIP0.5mm	○	○
310-140-10	Bipolar Forceps 20cm TIP 1mm	○	○
310-140-20	Bipolar Forceps 20cm TIP 2mm	○	○
310-180-10	Bipolar Forceps Angled 20cm TIP 1mm	○	○
310-180-20	Bipolar Forceps Angled 20cm TIP 2mm	○	○
310-182-10	Bipolar Forceps Angled Curved 20cm TIP 1mm	○	○
310-185-10	Bipolar Forceps Angled Curved 20cm TIP 1mm	○	○
310-112-05	Bipolar Forceps Curved 11,5cm TIP0.5mm	○	○
310-142-10	Bipolar Forceps Curved 20cm TIP 1mm	○	○
310-142-20	Bipolar Forceps Curved 20cm TIP 2mm	○	○
152-112	Blade curved electrode 7 cm	○	○
152-115	Blade electrode 16 cm	○	○
00404.07	Cable for connection neutral electrode F7915/F7930	○	○
F7915	Conductive rubber neutral electrode without cable	○	○
F7930	Conductive rubber split neutral electrode without cable	○	○
152-195	Conization electrode 13 cm	○	○
755VL	Disposable handle with finger switches	○	○
00301.03	Double water-proof foot switch	○	○
500500.L7/L	Drop electrode (L7) (5pcs) 10cm	○	○
500500.L7	Drop electrode (L7) (5pcs) 5 cm	○	○
F7520	Electrode cleaning sponge 47x50mm	○	○
00500.00/L	Kit of assorted electrode length 10cm (10pcs)	○	○
500500.L3/L	Loop electrode Ø 4mm (5Pz) 10cm	○	○
500500.L3	Loop electrode Ø 4mm (5Pz) 5cm	○	○
500500.L4/L	Loop electrode Ø 8mm (5Pz) 10cm	○	○
500500.L4	Loop electrode Ø 8mm (5Pz) 5cm	○	○
152-175-10	Loop electrode 10x10 l.15 cm	○	○
152-190-13	Loop electrode 20x13 l.15 cm	○	○
152-190-20	Loop electrode 20x20 l.15 cm	○	○
190-260	Monopolar cable M4-MP4 3mt	○	○
330-134-20	Monopolar Forceps 20cm TIP2mm	○	○
330-160	Monopolar Surgical Scissors 18cm	○	○
152-122	Needle curved electrode 7 cm	○	○
152-125	Needle electrode 13 cm	○	○
500500.L8/L	Noose electrode (L8) (5pcs) 10cm	○	○
500500.L8	Noose electrode (L8) (5pcs) 5 cm	○	○
00300.00	Not waterproof foot switch	○	○
00100.03	Power supply cable 2m 3x1mm SIEMENS-IEC	○	○
F4814	Reusable handle without finger switches	○	○
00400.00	Rod neutral electrode with cable	○	—
500500.L9/L	Straight ball electrode Ø 3mm (5pcs) 10cm	○	○
500500.L9	Straight ball electrode Ø 3mm (5pcs) 5cm	○	○
500500.L1/L	Straight thin wire electrode (5pcs) 10cm	○	○
500500.L1	Straight thin wire electrode (5pcs) 5cm	○	○
TR003	Trolley 3 shelves	○	○
TR003W	Trolley 3 shelves	○	○
TR004	Trolley 4 shelves	○	○
TR005	Trolley 5 shelves	○	○

●/ Pcs= STANDARD      ○= OPTIONAL      — = NOT COMPATIBLE

### General Description

DIATERMO MB 120 F and DIATERMO MB 200 F are high frequency electro-surgical equipments suited to deliver current for cut, coagulated-cut and coagulation (with different levels of coagulation) in monopolar modality and coagulation in bipolar modality.

In the bipolar coagulation modality can be activated a detection system of the tissues impedance with automatic activation and automatic stop when the coagulation is achieved (AUTOSTART – AUTOSTOP).

The current can be delivered for the whole time of activation of the output circuit or for an interval of time which can be preset.

The preset time delivery can be single, every time that the circuit of exit is activated, or repeated to in operation intervals of the performed planning.

A total of five different modes of use and levels of power, can be stored and recalled for the use simply.

It is possible to use either single plate neutral reference electrodes or electrodes with split conductive zone so to watch the stability of the plate to patient impedance during the surgical intervention.

Control of the units is via front panel keys and display; mains inlet is located on the rear panel.

The units have automatic control systems that, monitoring the internal parameters, signal the possible damages/errors that are found.

The level of the emission sound can vary; every operator can choose his own level according to the environmental conditions of working.

The units can work either through holder-handles with or without pushbuttons with double foot switch command.

It's possible to connect bipolar forceps to the unit for the bipolar functions.

## ELECTROPHYSICAL PRINCIPLES

In the electrosurgical interventions the traditional use of blade surgical is substituted by electrosurgical needle that allows making in a fast, simple and effective way the cut and coagulation of.

The electrosurgical needle is made on the principle of electrical energy conversion in heat and it's constituted by:

- a sinusoidal oscillator in radiofrequency
- a generator of wave packets, with repetition frequency of packets equal to 15 – 30 kHz
- a mixer for the transfer, to the power amplification block, of the only wave form adapt to the cut, or the only wave form for the coagulum, or a signal obtained by an opportune mixing of the two;
- a power amplification block able to supply the necessary power in terms of current and to transmit to the electrodes, by transformer, the amplified signal;
- a security circuit for the return electrode, to take possible cable interruptions and disarm the radiofrequency supply;
- by an active electrode opportunely shaped (handle);
- by a return electrode (neutral) that close the circuit by the patient

The current that crosses the biological tissue can cause:

1. Joule Effect
2. Faradic Effect
3. Electrolytic Effect

### 1) Joule Effect

In the biological tissue, crossed by electrical current, it's produced a heating (thermal effect), dependent by the electrical resistance of the tissue, by the current density, by the application time and that can determine many cellular transformations

$$Q = I^2 \times R \times T$$

The thermal effect influence (Joule Effect) is made by:

- **Current Intensity and output power**
- **Modulation level**

Parameters interpretable by the wave form of the high frequency current produced by the generator.

- **Electrode shape**

The electrode shape can be needle or rounded according to the necessity, it has reduced dimension; for this the current density on the point surface [ $A \cdot m^{-2}$ ] is highest. The electrodes with a thin section create a high current density, and high temperature, favoring the cut action. Those with a big surface create a smaller current density, a smaller temperature, realizing a coagulation effect.

- **State of active electrode**

The thermal effects can be reported to the human body resistance, to which must be added the electrode contact resistance. It's indispensable to maintain the active electrodes perfectly clean to not have a reduction of the.

- **Characteristics of the tissue**

The resistive characteristics change according to the biological tissues.

Biological tissue (range from 0,3 to 1 MHz)	Metals
Blood $0,16 \times 10^3$	Silver $0,16 \times 10^{-5}$
Muscle, kidney, heart $0,2 \times 10^3$	Branch $0,17 \times 10^{-5}$
Liver $0,3 \times 10^3$	Gold $0,22 \times 10^{-5}$
Brain $0,7 \times 10^3$	Aluminum $0,29 \times 10^{-5}$
Lung $1,0 \times 10^3$	
Fat $3,3 \times 10^3$	

*(Example of specific resistances of organic and metallic materials)*

According to the come temperature and in function of used pulse form, it's possible to recognize many types of effects produced by the current in radiofrequency on the human body:

### Coagulation

Temperatures from 60 to 70 °C in the area around the active electrode cause a slow heating of intra-cellular liquid, the water contained in the cell evaporates and an action of coagulum is obtained, so the blood flow is stopped.



## Cut

Temperature over 100 °C in the area around the active electrode determines the evaporation of the intracellular liquid and the cell explosion. The vapor around the electrode baits a chain reaction in the direction where the active electrode is worked, transmitting the evaporation energy to the tissues around it.

The cut isn't, for this, a mechanical resection. If the temperature comes to 500 °C it's verify the tissue with an action of cauterization.

## Mixed currents

They are obtained by the mixing of coagulation and cut effects. There is a reduction of blood loss during the cut procedure, or like cut that develops a substantial eschar coat.

The high frequency used by electrosurgical needle, don't allow to the electromagnetic field to penetrate deeply in the matter and so the current crosses the conductor mostly in the external surface, reduces in an exponential way and becomes negligible in the centre of the conductor section. This effect, called 'skin-effect' cause a reduction of the useful section for the current passage, an increase of the electrical resistance and becomes an important problem in the neutral electrode. In fact in this electrode the current density is very high (KA/m<sup>2</sup>) on the edge, where the excessive increase of temperature by Joule effect causes burns for the patient. So it isn't accidental that the burns for the patient, during the electrosurgical interventions, have the shape of the edge neutral electrode. To reduce the burns risk have to dose opportunely the supply power (I<sup>2</sup>·t) and to follow the rules for the application of the neutral electrode on the patient (see cap. SAFETY).

## 2) Faradic Effect

The pulsed current causes the neuro-muscular stimulation, originated by stimulation of physiologic process of ionic exchange, responsible of the transmission of stimulus that cause muscular spasms and cardiac symptoms of extra systole and ventricular fibrillation.

The effect of this stimulus is known like faradic effect and it is expressed by:

$$R = I / \sqrt{F}$$

The physiologic system of stimulus transmission follows a limit curve in which the pulsed currents or by low frequency produce an impulse of stimulation. By alternating current in high frequency (higher than 200 kHz), used in the electrosurgical needle, don't have neuro-muscular reactions (the change of polarity is so fast that the patient doesn't have consequences at a level of the neuro-muscular reactions), and there isn't an electrolytic damage of the organism.

For this reason all the equipments generator of the high frequency for surgical use (electrosurgical needle) work on base frequencies higher than 300 kHz so that they don't produce electric stimulation.

## 3) Electrolytic Effect

The use of high frequency currents reduces the electrolytic effect (ionic division) in the tissues, caused by the shortest period of unidirectional conduction of the current.

# OPERATIVE TECHNICIS

## Monopolar Cut

Monopolar cut is the sectioning of the biological tissue achieved by the high-density passage of HF current, which is concentrated at point of the active electrode. The HF current, when it is applied to the tissue, through the point of the active electrode, it creates intense molecular heat in the cells so high that explosion of it is caused. The cut effect is achieved by moving the electrode through the tissue and destroying the cells one after the other. The movement of the electrode prevents the propagation of the side heat in the tissue, thus limiting to a single line the cells' destruction.

The best HF current for cutting is pure sine wave without any modulation that cuts very smoothly and provides the least thermal effect with poor haemostasis while cutting. Because its effects can be precisely controlled, it can be used safely without damage to the bone, but since good coagulation while cutting is one of principal benefits of using electro surgery a current with a certain amount of modulation is desirable.

The following rules help the operator to obtain good cutting, however every user must follow first of all his professional judgment as he does every time in his practice.

- Keep the tissues moist but not wet;
- Survey the stroke before activate the electrode;
- Keep the electrode perpendicular to the tissue;
- Activate the electrode before making contact with the tissue;
- Maintain clean the electrode's tip (the optional sponges F7520 to clean the electrodes are advised);
- Wait at least five seconds before to repeat a stroke.

When the output power is properly set there should be:

- no resistance to the electrode movement through the tissue;
- no change in the cut surfaces color;
- no fibers of tissue remained onto the electrode.

## Monopolar Coagulation

When there is a temperature increment, for the heat produced for the Joule effect in the tissue, it's realized the thermal coagulation and that is the partial solidification of the liquids and so the precipitation of colloidal substances. In particular fibrin forms in the blood and it, solidifying itself, obstructs the blood vessels.

To obtain the coagulation by the electrosurgical needle it needs to supply the active electrode with intermittent current so that the water goes out from the cell without destroying it. However also with the intermittent current, if the intensity of the current is too intense, the cut effect is realized.

Active electrodes particularly adapted for the coagulation are the electrodes with sphere shape, plate, or lanceolate used laterally.

The coagulation can be obtained by two different methods: by desiccation and fulguration.

## Coagulation by desiccation

It's obtained supplying the electrode by low voltages that not generate sparks (this guarantees that the action is pure coagulum and so every effects of the cut is absent). The electrode is placed in direct contact with the tissue and the quantity of heat developed desiccates it.

Generally the coagulated cellular surfaces act like an insulation layer, that prevents that the heat had to the successive applications of the current penetrates too much in depth.

The current normally used for the coagulation is the modulated type. In function of the percentage of the modulation is realized the precision of the cut, the goodness of the haemostasis and the level of the tissue destruction. A bigger modulation of the current gives a cut more irregular, and a bigger depth of tissue destroyed but a better coagulation.

The following rules help the operator to obtain a good coagulation:

- select a ball electrode or a large wire;
- localize the vessel bleeding after have been dried the exceeding blood from the area;
- touch lightly the vessel bleeding before to activate the electrode;
- stop the activation of the electrode when the tissue whiten to prevent to damage it;
- maintain clean the point of the electrode (for this scope it's advisable to use (for this scope it's advisable using the electrode cleaning sponges F7520).

#### **Coagulation with anatomical forceps by the clamping**

The more used coagulation consists to stop the haematic flow by the clamping pressure between the ends of the forceps.

After have clamped the portion of the tissue or the blood vessel seat of the coagulation, the active electrode puts in contact with the proximal metal part of the forceps. The activation of the high frequency must be happen after this contact (forceps – active electrode) to prevent faradic effect (primer of an electric flat that exploits like conductor the air) that would cause electrical shock, burns to the operator, etc.

### ***Bipolar Coagulation***

In a different way from monopolar technical, with bipolar technique the portion of tissue interested by current passage in high frequency is very small. In this technique the bipolar forceps are used (with different dimensions and shapes) on which distal ends there are active and neutral electrodes. Clamping the interested tissue between the ends forceps, the current passage in high frequency will happen from an end to another one, exploiting the portion of tissue to treat like an electrical bridge.

- The bipolar coagulation is the haemostasis of small blood vessels of the body tissue between the two points of the forceps. When the current density is reduced the consequent effect is the desiccation of the cellular surface, without penetration in depth, with consequent coagulation.

The bipolar technique is extremely more safe because the current direction in high frequency is always determinate and not has unknown factors and probable erroneous directions, and the used powers are lower than those used in monopolar technique. For these reasons this technique is used above all in the more critical surgical operations, so it's important to maintain clean the distal ends of the forceps during the operation, because they are subject to accumulation of coagulated tissue, which limits the current passage and favors the sticking of the tissues.

The application of the neutral electrode (used obligatorily in the monopolar technique) isn't necessary, even if in a practical point of view it's always advisable the application on the patient during the initial preparatory phase.

## **CONTRAINDICATIONS AND COLLATERAL EFFECTS**

Electro surgery is not recommended in the following subjects:

- having pacemaker;
- with stimulating electrodes;
- with metal prosthesis plant;
- with important arterial pressure unbalance;
- with important nervous disorders;
- with renal insufficiency;
- in state of pregnancy.

Burns are the most consequences of the HF electro surgery for the patient, even if these are not the only one. In fact necrosis by compression, allergic reactions to the disinfectant, gas or inflammable liquids ignition.

Some important causes of burns are by:

- insufficient medical equippe training about all modalities to avoid or reduce the risks of burns by using HF electro surgical units;
- use of disinfectants with high alcol content;
- incorrect position of the patient during the electro surgical operation;
- contact between active electrode and the skin;
- contact with liquid;
- long application of HF currents;
- incorrect application of the patient-plate.

To avoid or reduce the common HF electro surgical risks it is very important to respect the rules and safety measurements exposed illustrate on the next chapter.

## **SAFETY**

**WARNING:** Electro-surgery can be dangerous. Careless use of any element in the electro surgical system may subject the patient to a serious burn. Read and understand all warnings, precautions, and directions for use before attempt to use any active electrode. Neither LED SpA, can be considered responsible for personal, material or consequential injury, loss or damage that results from improper use of the equipment and accessories.

The accessories supplied with the unit have characteristics compatible with this supplied unit, they could be incompatible with others electro surgical units; the user must check, before connecting other accessories to this unit, that they have characteristics of insulation compatible with those of this unit and utilized function (see Technical Characteristics).

It is recommended to inspect the integrity of the packaging of the sterile products.

## General

The following precautions reduce the risk of accidental burnings

- The whole surface of the patient plate must be placed on a well-vascularized muscle as next as possible to surgical area. Avoid connecting the patient plate to bony protrusions, prosthesis, cicatricial tissues, and parts of the body subjected to liquid accumulation or that present subcutaneous adipose tissue. The part of the body must be without hair, dry and clean. Do not use alcohol to clean the skin. Unless for veterinary use, the use of gelatinoids substances for the electrodes is not advised.
- By using the disposable neutral electrodes respect the date of expire.
- By using the reusable electrodes ascertain that the fixing systems give warranty of stability.
- When you apply the neutral electrode avoid the transversal course and prefer the vertical or diagonal course, in particular if a split neutral electrode is used. That to allow a uniform distribution of the current on the surface of the neutral electrode and reduce the risk of burn to the patient.
- If it isn't possible to use correctly the neutral electrode, consider, if it's possible, the bipolar technique instead of the monopolar one.
- The patient does not must be in contact with metal parts that are connected to the earth or have a large electrical coupling capacity to the earth (for example: operating-table or metallic support). The use of antistatic sheets is advised.
- Avoid the skin to skin contact (for example between arm and body of the patient). Insert an interface material like dry surgical gauze. Moreover, the parts of the body subjected to abundant perspiration must be maintained dry.

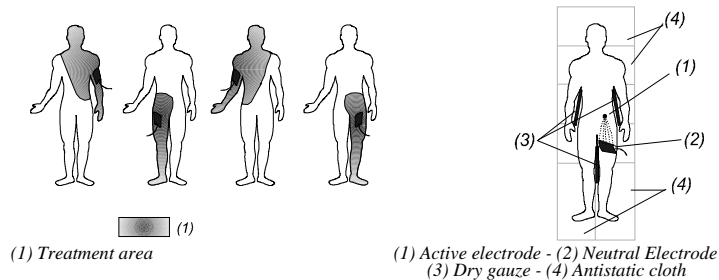

- When high frequency electrosurgical unit and physiological monitoring devices are used at a time in the same patient, all the monitoring electrodes, that have not resistive or inductive elements tested in high frequency interference environment, must be as far as possible from the electrodes of the electrosurgical unit. Avoid the use of monitoring needles.
- The connection to the electrodes should be located in such a way to avoid the contact both with the patient and with other cables.
- For surgical procedures where the HF current could flow through parts of the body having a relatively small cross-sectional area; the use of bipolar techniques may be desirable in order to avoid unwanted coagulation.
- The power level should be the lowest useful to the work to do.
- Always check the return plate whenever electrosurgical unit fails to produce the desired effect. Reason for a low output power level, or for an incorrect functioning of the electrosurgical unit when arranged for a normal output, may be lack of connection of the return plate or its imperfect placement.
- The use of flammable anesthetics, of oxygen and of nitrogen protoxide should be avoided in the case of operation at the head or at chest level except the possibility of evacuating gas. Flammable materials used to clean, or to disinfect, should be let to evaporate before the use of the electrosurgical unit. There is risk of stagnation of flammable solutions under the patient or in body cavities as the umbilicus and the vagina. The fluid that deposits in these areas should be removed before the equipment use. The danger of endogenous gas ignition has to be considered. Some materials like cotton wool or gauze, when saturated with oxygen, may burst into flames because of the sparks produced by the equipment in the normal use.
- There is a risk for the patients fitted with heart pacemaker or other stimulation electrode: interference may occur with the stimulator signal or the stimulator itself can be damaged. Please refer to Cardiology Unit when in doubt.
- Electrosurgical equipment does emit unnoticed radiation of high frequency energy that may effect other medical equipment, unrelated electronics, telecommunications, and navigational systems.
- The accessory must be regularly checked, particularly the cables for the electrodes and the possible accessories for the endoscopy to verify that the insulation is not damaged.
- To avoid the connection of incompatible accessories to the unit, the insulation characteristics of the items to be replaced must be requested to the manufacturer and compared to those of the supplied unit (see Technical Characteristics)
- **Attention:** a damage of the electrosurgical unit could result in an unwanted increase of the output power.
- Inadvertent stimulation of a patient's muscle and nerves can be caused by low frequency currents originating in electric sparks between electrode and tissue of the patient. Should neuromuscular stimulation occur stop surgery and check all connections to generator. If this does not solve the problem, qualified service personnel must inspect generator.

## Installation

- The electric safety is insured only when the same are correctly connected to an efficient net linked to the earth in conformity with the actual safety requirements. It is necessary to verify this fundamental safety requisite and, in case of doubt, to require an accurate control of the plant from part of qualified personnel. The manufacturer cannot be considered responsible for possible damages caused from the lack of efficient connection to earth of the installation. Operation without a protective earth connection is forbidden.
- Before connect the equipment ascertain that the required voltage (showed on the rear panel) corresponds to the available mains.
- In case of incompatibility between the available wall socket and the feeding cable of the equipment, replace only with legally approved connectors and accessory items. The use of adapters, multiple connections or cable extensions is not advised. Should their use become necessary it is mandatory to use only simple or multiple adapter conforming to the actual safety requirements.
- Don't let the apparatus exposed to atmospheric agents. The unit must be protected from seepage of liquids. Don't obstruct openings or cracks of ventilation or heathsink
- Don't leave the equipment uselessly inserted. Switch off the equipment when not in use.
- The use of the unit is not suited in explosive rooms.
- **DIATERMO MB 120 F – DIATERMO MB 200 F** must be destined only to the use for that have been expressly designed. Any other use is to be considered improper and dangerous. The manufacturer can not be considered responsible for possible damages due to improper, wrong and unreasonable uses.
- It is dangerous to modify or try modifying the characteristic of the equipment.
- Before effect any operation of cleaning or maintenance, disconnect the apparatus from the electric net, either unplugging it from the mains or switching off the mains switch of the plant.
- In case failure and/or bad operation of equipment switch off it. For the possible reparation address only to an authorized service centre and ask for the use of original spare parts. The lack to follow the above requirements could risk the safety of the equipment and can be dangerous for the user.
- Do not reduce or disable the audible signal warning the activation of the generator. A functioning activation signal can minimize or prevent patient or staff injury in the event of accidental activation.
- Avoid verifying the functioning of the unit by shorting the active electrode with the reference one or the active electrode with metallic parts.
- If necessary use a smoke-plume extraction system.

## Correct Position of the Patient

It is important to avoid any intention or accidental contact between patient and grounded metallic parts and to make sure that:

- The patient is not in contact with metallic parts (operative table, supports..).
- The flexible tube of the respirator do not touch the body of the patient.
- On the operative table with grounded connection there are always coatings that allow to discharge the electrostatic charges.
- The patient is on a thick basic tissue with insulating properties, covered by a sufficient number of nets.
- The patient is not in contact with nets or wet mattress.
- The eventual organic secretions and the cleaning and other liquids do not wet the nets.
- There are not liquid under the patient.
- Urinary secretions are eliminating by the catheters.
- The body zones characterized by a higher sweating, the extremities in direct contact with trunk or the points of skin-skin contact are dried by the nets interposition (arm/trunk, leg/leg, breast, skin folds, etc.).
- All conductive and grounded supports, stirrups, are correctly insulated.
- Control the anesthetics quantity to avoid a great sweating.

## Correct Position of Neutral Electrode

The use of the neutral electrode (or patient-plate for the leakage of current) is necessary in the monopolar technique, because it allows the "return" of the cutting or coagulation current to the scalpel. The types of the neutral electrode are two:

**neutral electrode by single surface** (with joint cables) where there is not a check on the contact between neutral electrode and patient.

**neutral electrode by two surfaces** (with divided cables) where there is a check on the contact between neutral electrode and patient.

Keep attention on the correct position of the patient-plate to avoid burns and other risks for the patient, we recommended regard to this by the following information.

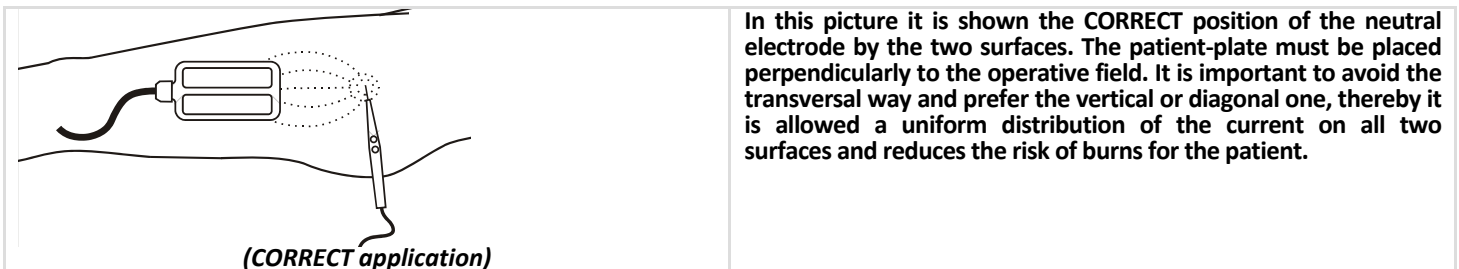

In this picture it is shown the **CORRECT** position of the neutral electrode by the two surfaces. The patient-plate must be placed perpendicularly to the operative field. It is important to avoid the transversal way and prefer the vertical or diagonal one, thereby it is allowed a uniform distribution of the current on all two surfaces and reduces the risk of burns for the patient.

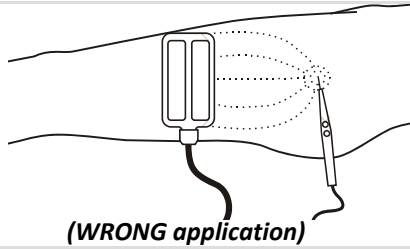

Neutral electrode is often applied in an **INCORRECT** way, in parallel to the operative field. So the current distribution is not uniform on the two surfaces. If possible that the OC acoustic signal is started and the unit starting is not allowed.

Before to apply the neutral electrode, clean and eliminate any external substances from its surface.

Do not apply the neutral electrode on cicatrix, bony protrusion or near prosthesis or monitoring electrodes. But apply it on sprinkled tissues, such as muscles and near the operative site. If you use a disposable neutral electrode respect the date of use, if you use a not disposable neutral electrode make sure that the fixing systems guarantee stability.

It is very important that the neutral electrode is firmly applied on its entire surface to avoid burns. When the neutral electrode is partially taken off from the patient, the current density on the remaining applied part is higher. Because the density of the current flow under the neutral electrode is not uniform, it verifies a not uniform heating, especially near the borders of the neutral electrode.

## HF Electrosurgical in Laparoscopy

Since its introduction minimally invasive surgery has revolutionized surgical operation offering any significant benefits to the patient of faster healing and less postoperative pain. In laparoscopy the monopolar HF electro surgery is the most used because it is highly versatile (pure cut, coagulation, blended cut that combines these two functions), but this modality can compromise patient safety by burns.

The constricted view of the surgical field, the poor maintenance of the laparoscopic instrumentation, interference on the video monitor, the insufficient training of the surgeon or his inattention, the smoke, the insulation failure, the capacitive currents, the contact of the tip of the active electrode with the surrounding tissue, these are all factors that increase the hazard of burns, intra-abdomen lesions, necrosis of the tissue, perforation of internal organs. The nature of the surgical environment – in which the active electrode is in close proximity to other conductive instruments and to tissue- may make the electrical currents transmission to unseen tissue off the laparoscope, causing unintentional tissue burns at non-targeted sites, by:

- direct coupling
- insulation failure
- capacitive coupling

Direct coupling occurs when the active electrode touches another metal instrument, transferring electrical current to it and possibly injuring tissue with which it comes in contact (for example bowel or other organs).

Insulation failure occurs when there is an excessive voltage, abuse, wear and tear, poor handling, or mechanical accident of the electrode shaft that happens during a single laparoscopic procedure or during disinfection and sterilization procedures. The breakdown along the unseen shaft of an activated electrode can allow electrical current to leak into surrounding non-targeted tissues, causing unobserved damage. Paradoxically, small cracks are more dangerous than large breaks because the current is more focused, and is therefore more likely to produce burns.

Capacitive coupling occurs when electrical current is induced from the active electrode to nearby conductive material, despite intact insulation. During HF electrosurgical operations the rapidly varying electrical field around the active electrode is only partially impeded by electrical insulation and creates stray electrical currents by alternately attracting and repelling ions in surrounding body tissue. Currents transferred in this way in nearby tissue can cause irreversible damage. The movement of electrically charged ions in capacitive coupled tissue can cause currents that can heat tissue sufficiently to produce burns.

Several measures are used during electrosurgical operations to limit and minimize the risks of patient injury:

- a better and more complete training for the medical staff;
- visual examination of the surgical instrumentation (active electrode, laparoscope);
- use of disposable electrodes (but the thinner insulation doesn't reduce the risk of breakdown or capacitive coupling);
- prohibiting the use of hybrid (plastic-metal) cannulas;
- adopting bipolar electro surgery (not-versatile, but safer, because the necrosis happen only if there is a long and continuous application of the current).

In the HF electro surgery burns are a real hazard that can be minimized by the knowledge of the causes and especially if the surgeon is prepared against these.

## INSTALLATION

- Inspect the unit for damages during transport. The claims for possible damages will be accepted only in case they are immediately communicated to the carrier; the damages that are found must be written down and presented to LED SpA or to your own retailer. If the unit is returned to the LED SpA or to your own retailer, it is necessary to use the original equipment's package or another equivalent one, to guarantee the safety during the transport.
- Unpack the equipment and carefully study the documentation and operating instruction supplied. Mains voltage, indicated above the inlet, must agree with the local mains voltage (mains voltage frequency: 50-60 Hz). The correct voltage (see above) setting is selected as shown in fig. E. Insert the correct fuses in the module referring to the value written on the label.
- The predisposition of the correct mains voltage is performed in the following way:
  - (A-B) Extract the fuse holder drawer from the power module.
  - (C) Insert the fuses making reference to the following chart:
 

Mains Voltage	110-120 V	Delayed Fuse 2x T6.3 A / 5 x 20 mm
Mains Voltage	220-240 V	Delayed Fuse 2x T3.15 A / 5 x 20 mm
  - (D) Extract and rotate the detachable part in way to read the correct voltage in the (E) window – reinsert the fuse holder in the module.

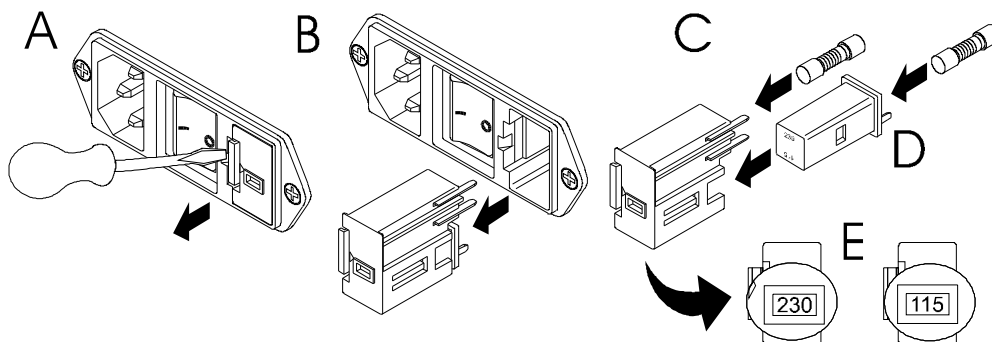

- Connect mains cable to a mains outlet having good earth connection.  
**OPERATION OF THE EQUIPMENT WITHOUT EARTH CONNECTION IS FORBIDDEN.**
- The unit must be installed on a level surface, with dimension, at least, correspondent to those of the base of the unit itself. Around the unit must be left a space of 25cm, at least.
- Connect the mains cable to the mains socket on the rear panel of the unit.
- Connect, if request, the equipotential binding post located at the left of the unit's back panel to eventual equipotential socket of the plant.
- Connect the single foot switch or the double foot switch (optional) to the connector on the frontal panel of the unit.
- Connect handle to the corresponding connector and in the case of use of handle without push-buttons it shall be connected on the "ACTIVE" buckle.
- Let unit work in dry environment only. Any verified condensate must be let evaporate before putting in operation the unit. Don't exceed the temperature environment or the allowed moisture.
- Environments condition:
 

	<i>WORK</i>	<i>TRANSIT/STORAGE</i>
Temperature:	10/40°C	-10/+50 °C
Relative moisture:	30/75%	10-100 %
Pressure:	70/106k Pa	50/106 kPa
- When the unit is switched on, through the on/off switch on the frontal panel, after having checked the internal parameters, it will work with the function and the power level utilized during the last switching (when the unit is switched for the first time the level will be 00).
- Before using the unit, it is necessary connect the cable to the patient plate. Both when single plate electrodes and when split plate electrodes are used it is necessary to confirm the impedance acceptance by pressing the key OK (see page 15). In this way, if the value of the impedance is acceptable, the OC indicator light will stop flashing.

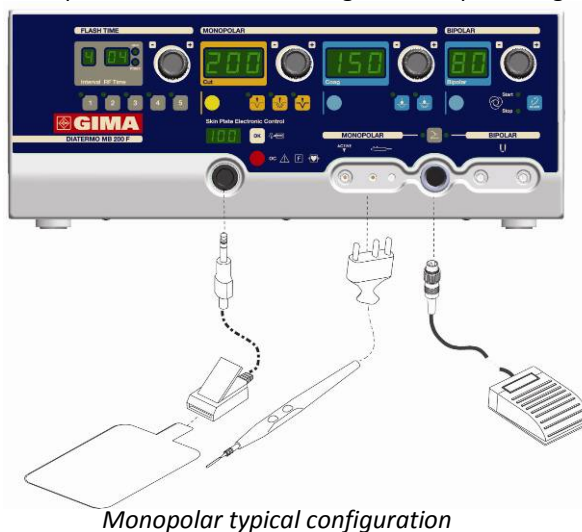

- Use for **MONOPOLAR**:



**Holder-handle with two pushbuttons without foot switch:** press the yellow pushbutton on the holder-handle to deliver the cutting current (the choice between CUT, BLEND or ENHANCED must be done pressing the correspondent pushbutton on the unit); or the blue pushbutton on the holder handle to deliver coagulating current (the choice between FORCED COAG or SOFT COAG must be done pressing the correspondent pushbutton on the unit).

**NOTE:** TO USE FOOT-SWITCH it's necessary to select Monopolar Foot-switch control (see figure).

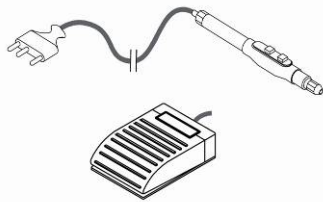

**Holder handle with two pushbuttons and a single foot switch:** choose the cutting current CUT, BLEND or ENHANCED and the coagulation current FORCED COAG or SOFT COAG. Preset through the yellow pushbutton on the holder handle, the function for the cut that appears on the unit or, through the blue pushbutton on the holder handle, the function for the coagulation that appears on the unit. Select The current delivery takes place through the foot switch.

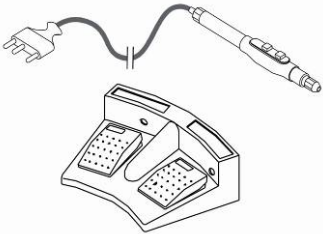

**Holder handle with two pushbuttons and optional double foot switch:** press the yellow foot switch or the yellow pushbutton of the holder handle to pre-set and deliver the cutting current (the choice between CUT, BLEND or ENHANCED must be done pressing the correspondent pushbutton on the unit) or the blue foot switch or the blue pushbutton of the holder handle to pre-set and deliver the coagulating current (the choice between FORCED COAG or SOFT COAG must be done pressing the correspondent pushbutton on the unit).

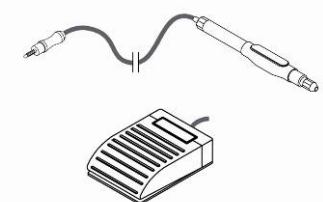

**Holder handle without pushbuttons (optional) and single foot switch:** connect the holder handle to the buckle indicated "ACTIVE" and pre-set the current for the cut CUT, BLEND or ENHANCED or the coagulation (FORCED COAG or SOFT COAG), press the foot switch to deliver the pre-set current.

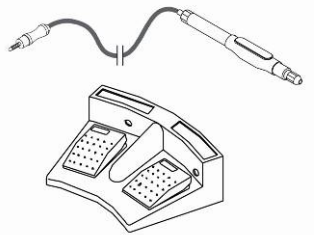

**Holder handle without pushbuttons (optional) and double foot switch (optional):** connect the holder handle to the buckle indicated "ACTIVE" and press the yellow footswitch to pre-set and deliver the cutting current (the choice between CUT, BLEND or ENHANCED must be done pressing the correspondent pushbutton on the unit); press the blue foot switch to pre-set and deliver the coagulating current (the choice between FORCED COAG or SOFT COAG must be done pressing the correspondent pushbutton on the unit).

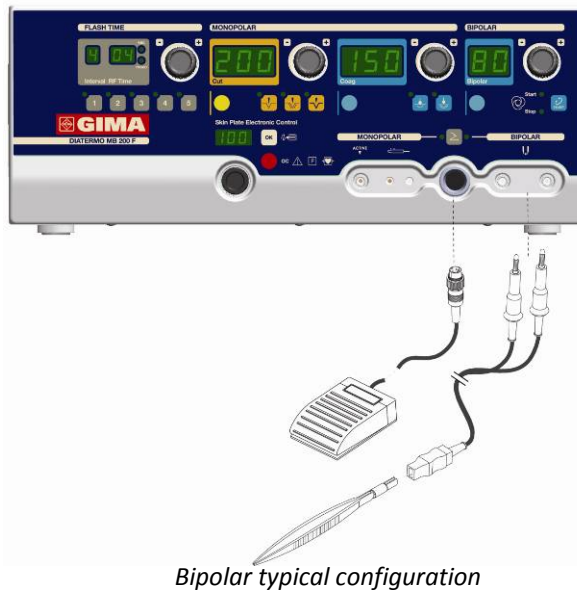

▪ Use for **BIPOLAR**:

**NOTE:** TO USE BIPOLAR it's necessary to select Bipolar Foot-switch control (see figure).

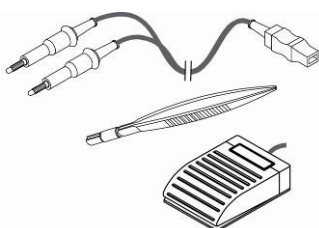

**Bipolar forceps (optional) and single foot switch:** connect the optional cable and bipolar accessory (see page 4). To deliver the current press the foot switch. To avoid the forcep's damage don't make short circuit with its tips.

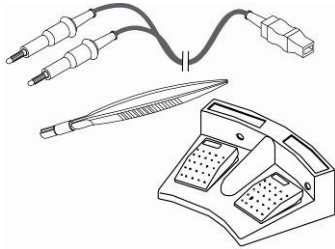

**Bipolar forceps (optional) and double foot switch (optional):** connect the optional double foot switch, the bipolar cable and the bipolar accessory (see page 4). To deliver the current press the foot switch for the coagulation (blue). To avoid the forcep's damage don't make short circuit with its tips.

**NOTE:** For BIPOLAR procedure you need other optional accessories:

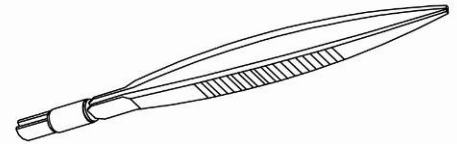
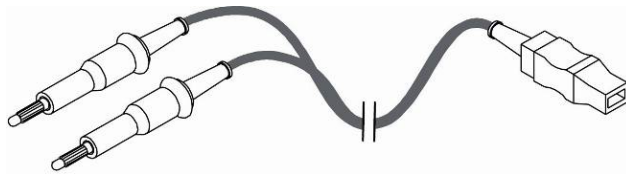

1 Cable for bipolar accessories connection  
2 Bipolar accessory (ex: bipolar forceps)

For optional accessories see page 4

## CONNECTOR AND CONTROLS

### Label on the Rear Panel

The requirements for the safety of H.F. surgical equipment ask data and graphic symbols must be printed on the cabinet or on at least one of the panels of generator unit to define its features and oversee its condition of work.

### Manufacturer's Identification Data

**DIATERMO MB 120 F – DIATERMO MB 200 F** HF electrosurgical unit are designed, manufactured and tested by the LED SpA in its own laboratories in Aprilia (LT) – Italy.

### Technical Data

#### DIATERMO MB 120 F

Output CUT (CUT):	120W - 250Ω	FREQUENCY:	600 kHz
Output BLEND (CUT/COAG):	90W - 200Ω	FREQUENCY:	600 kHz
Output ENHANCED (CUT):	90W - 250Ω	FREQUENCY:	600 kHz
Output FORCED COAG (COAG):	80W - 150Ω	FREQUENCY:	600 kHz
Output SOFT COAG (COAG):	60W - 100Ω	FREQUENCY:	600 kHz
Output BIPOLAR COAG (COAG):	60W - 50Ω	FREQUENCY:	600 kHz

#### DIATERMO MB 200 F

Output CUT (CUT):	200W - 250Ω	FREQUENCY:	600 kHz
Output BLEND (CUT/COAG):	120W - 200Ω	FREQUENCY:	600 kHz
Output ENHANCED (COAG):	120W - 250Ω	FREQUENCY:	600 kHz
Output FORCED COAG (COAG):	150W - 150Ω	FREQUENCY:	600 kHz
Output SOFT COAG (COAG):	90W - 100Ω	FREQUENCY:	600 kHz
Output BIPOLAR COAG (COAG):	80W - 50Ω	FREQUENCY:	600 kHz

MAIN POWER:	115/230 V - 50/60 Hz selecting
INLET POWER:	350VA
FUSE:	(230Vac) 2xT 3.15A / (115Vac) 2xT 6.3A
DUTY - CYCLE:	intermittent 10 seconds emission / 30 seconds of pause
CLASS:	I CF

### Meaning of Graphics Symbols

The meaning of the graphic symbols printed on **DIATERMO**'s cabinet is the following:

- 1- Floating Patient's plate: neither at low-frequency nor at high frequency earth connected.
- 2- The equipment is CF class, protected against Cardiac Defibrillator discharge.
- 3- Not Ionizing Radiation emitted.
- 4- Read carefully INSTRUCTION MANUAL before to attempt the use of the equipment.
- 5- Corresponding to the Directive Medical Device 93/42/EC
- 6- The product mustn't be threw in the containers for urban wastes but it must be swallowed by a separate picking.

1	2	3	4	5	6



## Frontal Pannel



1. Display for interval of pulse
2. Display for time-pulse
3. Encoder/Handle for FLASH TIME section
4. Display for indication MONOPOLAR cut level
5. Selection keys for cut mode
6. Knob for cut level
7. Warning light for cut output MONOPOLAR
8. Display for indication MONOPOLAR coagulation level
9. Selection keys for coagulation mode
10. Knob for MONOPOLAR coagulation level
11. Warning light for coagulation output MONOPOLAR
12. Display for indication BIPOLAR coagulation level
13. Knob for BIPOLAR coagulation level
14. Select key for bipolar automatic coagulation
15. Warning light for coagulation output BIPOLAR
16. Display for impedance reading
17. Key for acceptance impedance
18. Alarm indicator for excessive impedance in the neutral electrode circuit
19. Selection key for MONOPOLAR / BIPOLAR footswitch control
20. Bipolar output connector
21. Foot-switch connector
22. Handle connector for active electrode-holder for monopolar cut and coagulation
23. Connector for neutral electrode connection
24. Keys for memorization operational conditions

## Operation Mode

### Switch On

When switched on the electrocautery unit reports performs automatically a test to establish the correct operation of itself and of the connected accessories as well. In case anomaly is found, it is shown coded according to the chart codes brought in the chapter MAINTENANCE. This test lasts about 10 seconds. At the end of the control the equipment restores last use operational conditions, and activate the signal of alarm OC (open circuit).

### Neutral Electrode's Circuit (Skin Plate Electronic Control)

The neutral electrode's circuit is continually watched by a special circuit (Skin Plate Electronic Control) that prevents danger of burns to the patient due the loss of contact between the reference plate and the patient skin. The circuit is also watched to avoid that the variation of the characteristics of conductivity of the plate can provoke reduction of conductivity of the circuit, and therefore danger of burns to the patient.

The value of impedance found in the circuit of the neutral electrode is shown (by OC alarm lightening) to the operator that, if he considers it suitable to the job to develop, he accepts it by pressing the OK push button. If the value of impedance is excessive its acceptance it is not acknowledged by the microcontroller of the equipment (written 'UP' appears on the display), therefore the signal OC is not extinguished and the distribution of power has not allowed.

In order to reduce the acoustic pollution, the sound alarm is present only when pressed the foot-switch.

If a single plate electrodes use watched only the connection of the neutral electrode plate to the unit.



If the impedance value is accepted, the impedance indication is recognized and the display and OC indicator are extinguished. If the shown impedance is accepted, but the impedance increases respect the accepted value, the unit avoid the distribution, shows the OC condition, without acoustic signal (only present during distribution) and shows the new impedance value.

## Repetition interval of the impulses and presetting of the supply time



In the section FLASH TIME, it is possible to set the number of repetition (INTERVAL) of the impulses and their duration (RF TIME). The adjustable value is indicated by the point on the display. To move the point from Interval (regulation impulses interval) to RF Time (presetting of supply time) push the knob encoder. To regulate the selected value (the one indicated by the point) turn the knob encoder.

The **duration of the impulses** is indicated by the double display (RF TIME):

The equipment can be set to obtain the power supply during all the time of activation of the output circuit (indication CO) or for the power supply in a programmed time from 10 milliseconds to 30 seconds.

For the setting of the time follow the table below:

RF TIME	Spia	Supply Time		Step
		From	To	
10÷90	mSec	10 mSec	90 mSec	10 mSec
0.1÷0.9	Sec	0.1 Sec	0.9 Sec	0.1 Sec
1.0÷9.5	Sec	1 Sec	9.5 Sec	0.5 Sec
10÷30	Sec	10 Sec	30 Sec	1 Sec
CO	mSec	During all the activation time of the output circuit (button handle or foot switch)		

**NOTE:** To not use the temporized function (to obtain the supply during the activation time of the output circuit) set on RF TIME, the indication CO.

The function RF time can be settled with all the functions, but do not interfere on the function AUTOSTART/AUTOSTOP in BIPOLAR modality.

The interval of the **repetition** of the impulses is indicated by the single display (INTERVAL):

The supply with the programmed duration of the impulses can be repeated, as long as the output circuit would be maintained active, for a presetting number of times (from 2 to 9 time). The interval from one repetition to another one is equal to the double of the duration of the impulse.

**NOTE:** Setting the value 1 there will be only one impulse. Setting the value 0 there will be a cycle of repetition of the impulses during all the time of activation of the output circuit.

The function Interval is not activated if the duration of the impulse (RF TIME) is equal to CO.

## Memorization of the directions for use



Using the five buttons is possible to memorize 5 different operative modality and power levels.

Considering that:

- An empty position is characterized by the corresponding green led turned off. Pushing shortly the button there will be a sound and the led will turn on.
- A preset position is characterized by the corresponding green led turned on. Pushing shortly the button there will be a sound and the led will turn on.

To memorize the parameters is enough to follow this procedure:

Keep push for a long time the button to whom have to be associate the settings (functions/levels/impulse duration/impulses intervals) to memorize. When the memorization is completed there will be a double sound.

**NOTE:** If you push a button to whom has been previously memorized settings (green led turned on), modifying one of the settings, the led will turn off. To memorize these modifications, repeat the procedures of memorization (extend pressure of the button till the double sound). To recall the old setting, push shortly the button.

## Monopolar

The supplying currents in the monopolar way for cut, coagulated cut and coagulation can be predisposed by the keys present in the MONOPOLAR section. The power level for every function can be predisposed by the knob level of CUT, and COAG sections. The set power levels remain in the memory.



(Fig. 1)

**MONOPOLAR**

Cut

COAGULATION

HANDLE CONNECTOR AND MONOPOLAR  
FOOT SWITCH SELECTION

- 1 Cut
- 2 Blend
- 3 Enhanced Cut

- 4 Forced Coag
- 5 Soft Coag



**Note:** For use foot-switch, press keys and view monopolar foot-switch light.

The description of the supplying currents is in the next paragraphs, according to the predisposition order of the selection keys, in the MONOPOLAR (see Fig. 1).

**Current for Cut (CUT)**



The best current for the cut is the pure sinusoidal wave without modulation that means with duty-cycle 100%. Such current, proper for cut without coagulation.

**Corrente Miscelata (BLEND)**



The mixed current (BLEND) it is suited for coagulated cut when a deep coagulation together the cut is desired. This current is made by sine current suited or the cut associated to low voltage current suited for coagulation (deep coag). With this, a MIXING current suited for cut coagulated in absence of eschar and carbonization is obtained, particularly suitable for endoscopic surgery.

**Current for Enhanced Cut (ENHANCED CUT)**



The ENAHNCED CUT current is a sinusoidal current characterized by modulation in amplitude and it is suitable to cut the tissues, in particular adipose tissues.

**Current for Superficial Coagulation (FORCED COAG)**

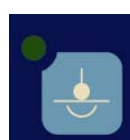

The modulated current (SPEEDY COAG) it is characterized by good property of surface coagulation behaving at the time it probable production of eschar and partial carbonization of the tissue. The advantage of this type of coagulation resides in the rapidity with which the effect is gotten.

*FORCED Coag also said Fulgurate or Speedy.*

**Current for Deep Coagulation (SOFT COAG)**

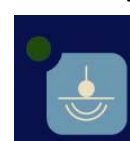

The low voltage and low modulation current (DEEP COAG) it is suited for coagulation of deep layers of the fabric in which the coagulation of the cellular albumin is gotten in absence of carbonization and without production of eschar. The process of coagulation is in this case more time expensive than that of the Speedy coagulation.

*SOFT Coag also said Pin Point, Dessicate or Deep.*

## Bipolar

The power level for bipolar function can be selected by the level Knob of Bipolar sections. The power levels selected remains in memory.



(Fig. 2)

### BIPOLAR COAGULATION

Bipolar Coag

### BIPOLAR ACCESSORIES CONNECTION AND BIPOLAR FOOT SWITCH SELECTION



**Note:** Use foot-switch, press keys and view bipolar foot-switch light.

Using BIPOLAR function it will need to connect the bipolar forceps to the connector for this function (BIPOLAR) and to use the foot-switch.

### Current for Bipolar Coagulation (BIPOLAR COAG)

Type of coagulation practicable with bipolar forceps and that allows to supply, by handle or foot-switch, the RF output power on a low impedance value. This value is normally on the section of tissue between the forceps. This modality is practicable by SELECT key (see Autostart and Autostop paragraph).

### Autostart and Autostop



In the 'Bipolar' section there is the SELECT key, by this to enter to different four settings for the bipolar coagulation:

- 1) **No automatism** for the distribution (at the first use of the device). The distribution is realized by pressing the foot-switch and stops by leaving again the foot-switch;
- 2) **START**. The selection of this function is realized at a first pressure of the SELECT key and it's indicated by the lightening of the corresponding warning light. The distribution is started, by pressing the foot-switch, if there is contact between active electrode and tissue, and it stops by leaving again the foot-switch;
- 3) **STOP**. The selection of this function is realized at a second pressure of the SELECT key and it's indicated by the lightening of the corresponding warning light. The distribution is started, by pressing the foot-switch, (if also there isn't a contact between tissue and active electrode) and stops itself for the impedance value higher than 200 Ohm. So by pressing the foot-switch, if there is an impedance value higher than 200 Ohm, the distribution doesn't start.
- 4) **AUTOSTART/AUTOSTOP**. By this setting, practicable by three pressures of the SELECT key indicated by the lightening of the START and STOP warning lights, the bipolar coagulation can automatically be activated and disarmed. The distribution starts, by pressing the foot-switch, if there is a contact between tissue and active electrode and stops for the impedance values higher than 200 Ohm. So by pressing the foot-switch, if there is an impedance value higher than 200 Ohm, the distribution doesn't start.

Another pressure of the SELECT key brings again to the no automatism function (1).

### Signaling of Excessive Time of Delivery

If the operator exceeds the maximum time of disbursement, recommended by the international norms, that is 10 seconds, after a time depending from the type of current, and from the level of the same one, the equipment could generate a signal of warning consisting in the text **Hot** flashing on the display and in impediment to the delivering of current. The interdiction lasting of the current delivery depends from the previous conditions of delivery.



### Signaling of Excessive Impedance in the Circuit of Neutral Electrode (OC)

For the meaning of this warning signal please refer to the previous description of the neutral electrode circuit. The warning light OC lightening if the circuit is open, it is extinguished by closing the plate and there is a respect for parameters selected and, in phase of distribution it's with an acoustic signal.

### Adjustment of the Acoustic Signal Level

To modify the emission acoustic signal it is necessary to follow those indications:

1. Switch on the unit through the mains switch while the CUT pushbutton is maintained pressed
2. When the unit has finished to check internal parameters, on the display CUT appears the message SOU., while on the COAG one, the value of the preset level. Now, the CUT pushbutton can be released.
3. Through the COAG knob it is possible varying the emission acoustic level. During the variation the sound emitted by the unit corresponds to the preset level.
4. Press the CUT pushbutton to confirm the level.

Level	Sound emission until 1m distance from the frontal panel
1	55 dBA
2	60 dBA
3	65 dBA
4	70 dBA
5	75 dBA

### Automatic Control of the Internal Parameters

The unit has an automatic control system of some of the internal parameters. When switched on, the control is indicated on the display through the message **SEL FCh**. If there are not errors, the message **PAS Sed** appears; if there are errors, **Err xxx** appears. See Guide to the Problems' Solution for further information.

### Connectors

#### Patient plate connector

This is the point of connection for the neutral electrode to apply on the patient.

Remember that the neutral electrode can be disposable and reusable.



#### Handle connector for the monopolar cut and coagulation

This is the point of connection for the handle with double push-buttons to realize the functions of the cut CUT and coagulation COAG.

Remember that the handle without push-buttons must be connected to the 'active' connector.



**Bipolar accessories connector**

Point of connection for the bipolar accessories, by which the bipolar currents can be distributed to realize the bipolar coagulation.



**Back Panel**

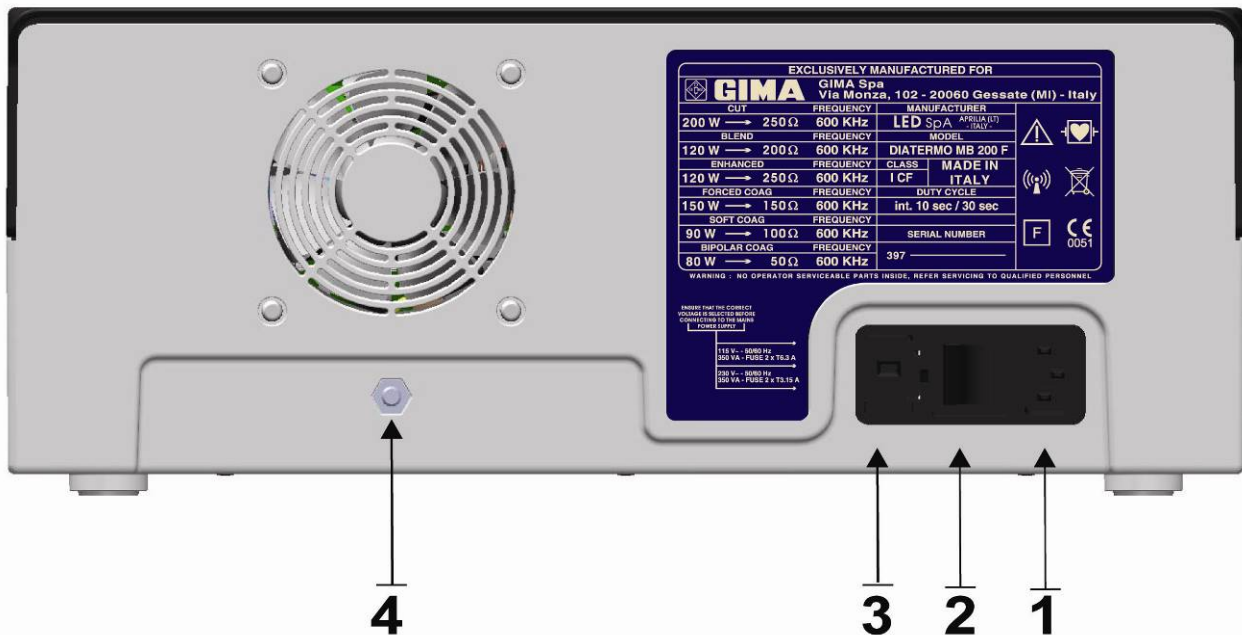

Mod. MB 200 F

- 1 Mains voltage connector
- 2 Power On-Off switch
- 3 Fuses holder/Voltage selector
- 4 Equipotential connector

**Power Supply Module and Voltage Selector**

Power supply module is the connection point of mains voltage feeding to the unit. This module is provided with line fuses and the voltage selector.

**WARNING:** before switch on the unit, operator has to verify that requested mains voltage corresponds to the voltage available from the electrical net. (see chapter INSTALLATION).

**Power On-Off Switch**

The POWER ON/OFF mechanical switch is used to control power to the equipment. To power the equipment, press the switch in the direction of the 1. Pressing the switch in the 0 direction will cut power to the equipment, this operation allows it to be used as a emergency stop switch, in the event of any fault.

## TECHNICAL CHARACTERISTICS

Tolerance	Description	DIATERMO MB 120 F	DIATERMO MB 200 F
–	Electrosurgical unit code	GMA10300.101	GMA10300.401
–	Bipolar coag with automatic activation/disactivation	●	●
–	Detection system of tissue impedance (Bipolar coagulation – auto start/autostop)	●	●
–	Repetition of timed delivery	●	●
–	Timed delivery (10msec - 30sec)	●	●
–	Minimum preselectable power	0	0
–	Selection of the power through the monopole-encoder	●	●
± 20%	Maximum output power CUT (W)	120W → 250Ω	200W → 250Ω
± 20%	Maximum output power BLEND (W)	90W → 200Ω	90W → 200Ω
± 20%	Maximum output power ENHANCED (W)	90W → 250Ω	90W → 250Ω
± 20%	Maximum output power FORCED COAG (W)	80W → 150Ω	80W → 150Ω
± 20%	Maximum output power SOFT COAG (W)	60W → 100Ω	60W → 100Ω
± 20%	Maximum output bipolar power BIPOLAR COAG (W)	60W → 50Ω	60W → 50Ω
± 5%	Modulation factor ENHANCED (Hz)	1.25	1.25
± 5%	Modulation factor FORCED COAG (kHz)	10	10
-0.1 + 0.2	Crest Factor CUT	1.5	1.5
± 0.3	Crest Factor BLEND	2.5	2.5
± 0.3	Crest Factor ENHANCED CUT	2.0	2.0
± 0.2	Crest Factor FORCED COAG	2.8	2.8
± 0.3	Crest Factor SOFT COAG	1.6	1.6
-0.1 + 0.2	Crest Factor BIPOLAR COAG	1.5	1.5
± 20%	Working frequency	600 kHz	600 kHz
± 15%	Maximum output voltage CUT (Vpp)	1500	1500
± 15%	Maximum output voltage BLEND (Vpp)	1800	1800
± 15%	Maximum output voltage ENHANCED CUT (Vpp)	1500	1500
± 15%	Maximum output voltage FORCED COAG (Vpp)	1500	1500
± 15%	Maximum output voltage SOFT COAG (Vpp)	700	700
± 15%	Maximum output voltage BIPOLAR COAG (Vpp)	700	700
± 0.5	Size LxHxP mm	370x144x319	370x144x319
± 10	Weight (kg)	6	6
± 5%	Selectable mains power (Vac)	115 – 230	115 – 230
± 1%	Mains frequency (Hz)	50-60	50-60
± 0	Fuses 230Vac (5x20) TIMED	2xT 3.15A	2xT 3.15A
± 0	Fuses 115Vac (5x20) TIMED	2xT 6.3A	2xT 6.3A
± 10%	Electrical input power (VA)	350	350
± 10%	Electrical input current (230Vac) (A)	1.5	1.5
± 10%	Electrical input current (115Vac) (A)	3	3
–	Five steps adjustable sound level	●	●
–	Self-check	●	●
–	Power accuracy output warning	●	●
–	Skin Plate Electronic Control <sup>1</sup>	●	●
–	Split or not split patient plate allowed	●	●
–	Working condition storing <sup>2</sup>	5	5
–	Electrical Class (EN60601-1)	I CF	I CF
–	MDD 93/42/EC Class	II b	II b
–	EN55011 (CISPR 11) Class (Class/Group)	2 / B	2 / B
–	Patient circuit	10 / 30	10 / 30
–	Duty Cycle (action / pause) in seconds	●	●
–	Output power control by foot-switch or finger-switch	●	●
–	Defibrillation-proof	●	●
–	Equipotential binding	●	●

● = PRESENTE

<sup>1</sup> Patient to plate contact monitoring system

<sup>2</sup> Continuous storing of the last settings

## MAINTENANCE

### General

No user adjustable parts are within the equipment, either for calibration or service purposes. The equipment housing must not be opened: the warranty is invalidated by any unauthorized entry into the unit. In the event any repair or adjustment work being necessary, the whole equipment should be returned to the LED SpA. Service Centre 04011 APRILIA (LT) - ITALY, or to an other Authorized Centre, together with a description of the fault. Maintenance work by the user is mainly the cleaning of the exterior of the cabinet, cleaning and sterilization of the accessory items and checking of the equipment before each use. Carrying out function and safety check for verification of the parameters is demanded to specialized technical people.

### Cleaning of the Cabinet

Switch the equipment off completely and disconnect the mains supply before any cleaning is undertaken. Clean the outside of the cabinet with a damp cloth. No chemical should be used; a mild non abrasive cleanser may be used when necessary.

### Cleaning and Sterilization of the Accessories Items

The best thing to do is to use only one time use accessories and discard them after use. Since some of the accessory items are to be used more than once it is mandatory to clean carefully and sterilize those accessories before the new use. The best way to clean and sterilize the reusable items is to follow the direction of the supplier of each item. When original reusable accessories supplied by LED SpA are applied, the cleaning by using deep cleanser and sterilization through steam sterilization at 121 °C / 134 °C is recommended.

### Guide to the Solution of the Problems

In case of problems before all it is advised to check for the correct installation of the unit and for the correct connection of the accessories.

Problems	Probable Cause	Solution
The equipment doesn't switch on.	Interruption or absence of the main feeding.	Verify the connection of the main cable. Verify the fuses and replace them, where necessary, with new ones of the proprie type.
Alarm OC always active	Interruption or lack of contact on the neutral electrode circuit.	Check the connection of the cable to the neutral electrode. Replace the cable of connection of the neutral electrode.
The unit doesn't respond to the command of activation	Breakdown of the handpiece or of the pedal. Wrong connection of the handpiece or of the pedal. Alarm OVT activated.	Replace the handpiece or the pedal. Verify the connection of the handpiece or of the pedal. Wait for the OVT warning signal getting out.
Error Code 001	Current delivery control activated during switching on.	Disconnect the handpiece or the pedal and switch on the unit again.
Error Code 002	Error in the management board.	Call for Service.
Error Code 003	Error in the management board.	Call for Service.
Error Code 004	Error in the data conversion circuit.	Call for Service.
Error Code 005	Error of the reference voltage value.	Verify the main voltage. Call for Service.
Error Code 009	Error in the output power activation circuit.	Call for Service.
Error Code 010	Error in the output power activation circuit.	Call for Service.

### Repairs

High frequency cables and electrode holder handle cannot be repaired. Always substitute a damaged part with a new one.

### Fuses Substitution

**Before substituting the fuse, disconnect the unit from the mains system**

Only use fuse of the kind 5x20, proceed as follows:

(A-B) Extract the fuse holder drawer from the power module.

(C) Insert the fuses making reference to the following chart:

Mains Voltage 110-120 V Delayed Fuse 2x T6.3 A / 5 x 20 mm

Mains Voltage 220-240 V Delayed Fuse 2x T3.15A / 5 x 20 mm

(D) Extract and rotate the detachable part in way to read the correct voltage in the (E) window – reinsert the fuse holder in the module.

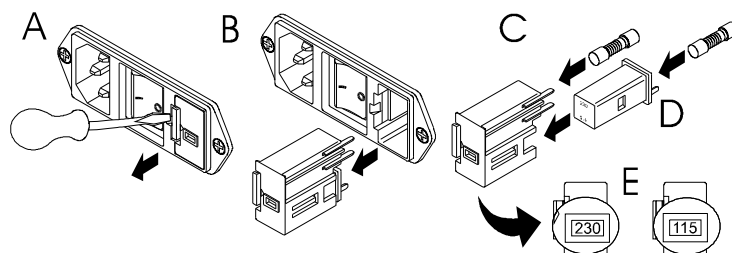



### ***Checking of the Equipment Before Each Use***

Each time the use of the electrosurgical equipment is planned a check of the most important safety aspects has to be implemented considering at least the following:

- Check the integrity of cords, connections, wires breakage, etc.
- Assure that all the electrical equipment is properly grounded
- Assure that all the accessories that should be used are available and sterilized.
- Check, by disconnecting the reference electrode cable, the functioning of the OC light. Active unit and check OC light and sound alarm warning.
- Check, by activating the CUT and COAG power switch, the functioning of the emission lights and sounds warnings.

### ***Function and Safety Check and Test***

At least once a year, the biomedical engineering department or other qualified personnel should do the following check and test:

- Check of the connectors and mains supply cord conditions;
- Visual check of the mechanical protections;
- Check of the protections against the danger due to liquid's pouring, dripping, moisture, liquid's penetration, cleanliness, sterilization and disinfection.
- Check of the Equipment's Data on the Label
- Check of the availability of the Instruction's Manual
- Check the functioning of the H.F. output controls
- Check the uniformity of the resistance through the surface of the patient plate.
- Test the earth conductivity resistance.
- Test the earth leakage current.
- Test H.F. leakage current.
- Control of the neuromuscular stimulation.
- Control of the accuracy of the output power.

**DIAGRAMS**

**DIATERMO MB 120 F**

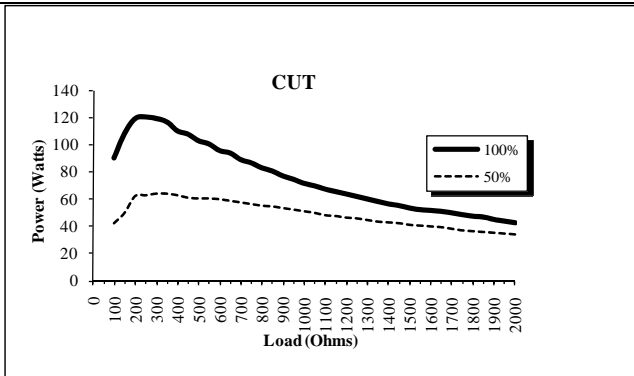

Diagrams of half and maximum output power versus impedance load 100-2000Ω CUT 100%

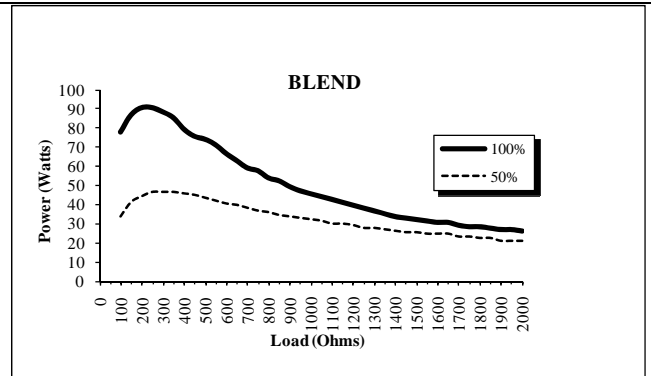

Diagrams of half and maximum output power versus impedance load 100-2000Ω BLEND

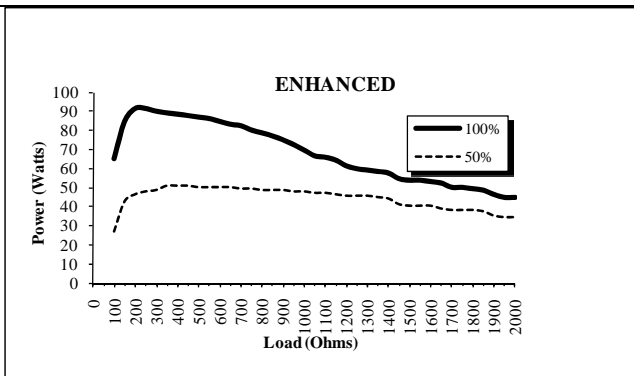

Diagrams of half and maximum output power versus impedance load 100-2000Ω ENHANCED

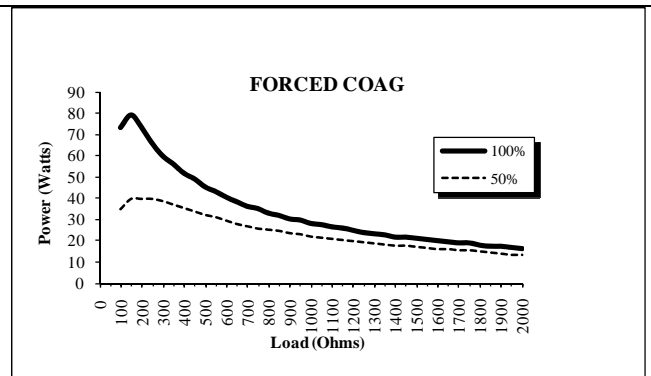

Diagrams of half and maximum output power versus impedance load 100-2000Ω FORCED COAG

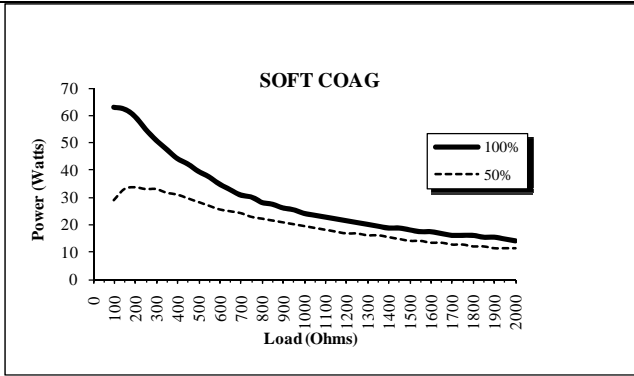

Diagrams of half and maximum output power versus impedance load 100-2000Ω SOFT COAG

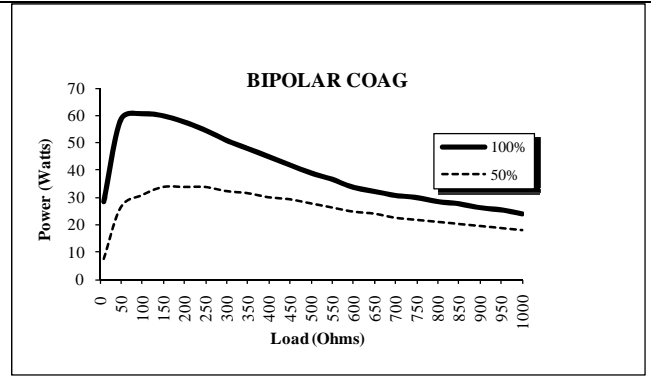

Diagrams of half and maximum output power versus impedance load 10-1000Ω BIPOLAR COAG

DIATERMO MB 120 F

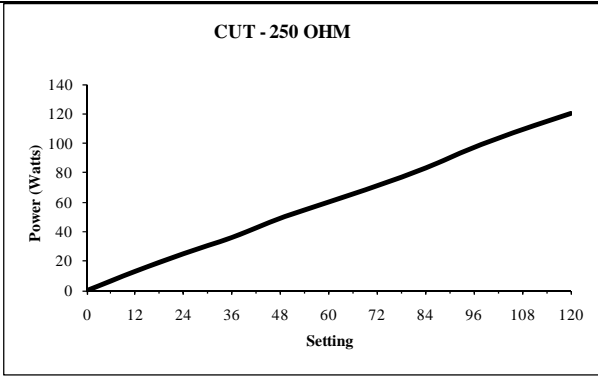

Diagrams of output power versus nominal value  
CUT100%

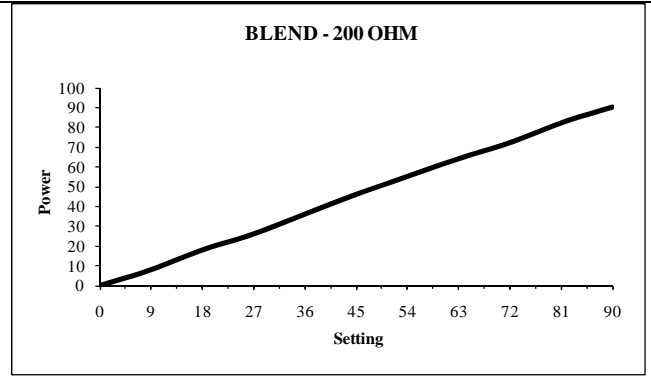

Diagrams of output power versus nominal value  
BLEND

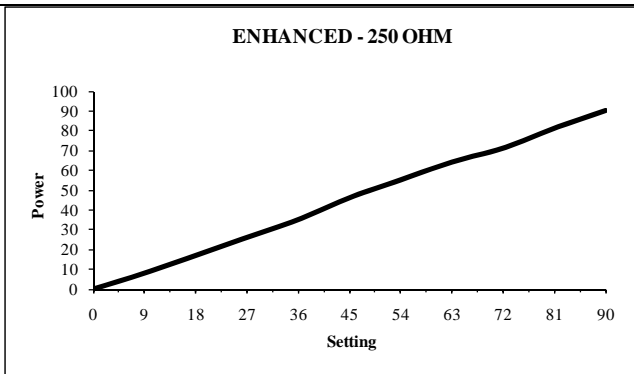

Diagrams of output power versus nominal value  
ENHANCED

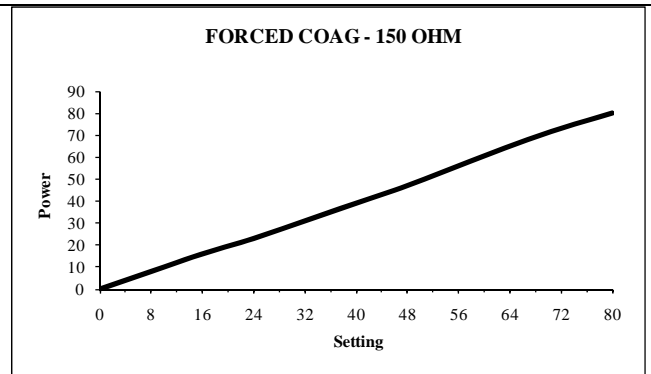

Diagrams of output power versus nominal value  
FORCED COAG

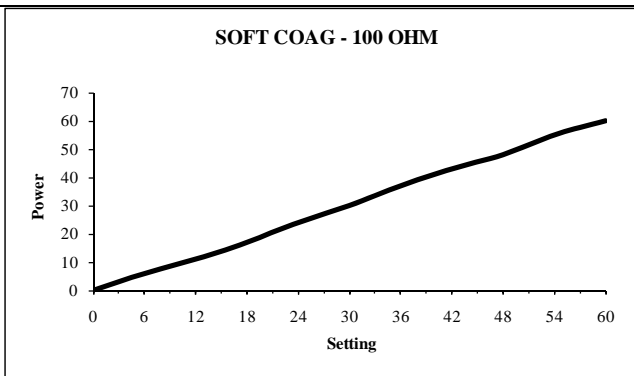

Diagrams of output power versus nominal value  
SOFT COAG

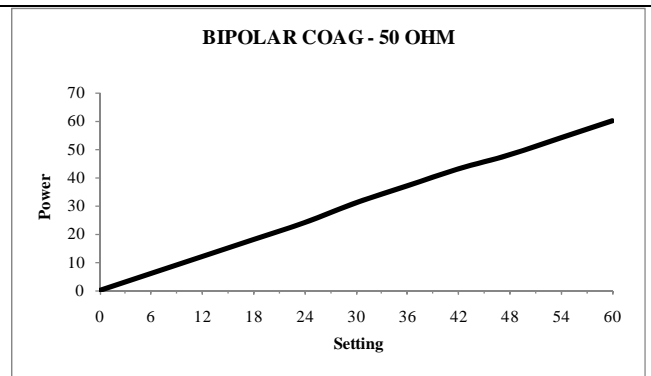

Diagrams of output power versus nominal value  
BIPOLAR COAG

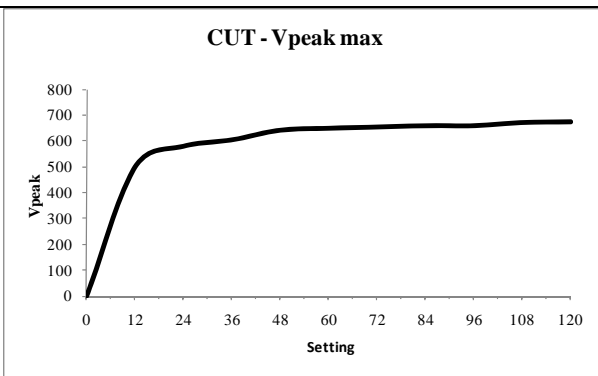

Diagrams of maximum mains voltage output versus Vp  
CUT100%

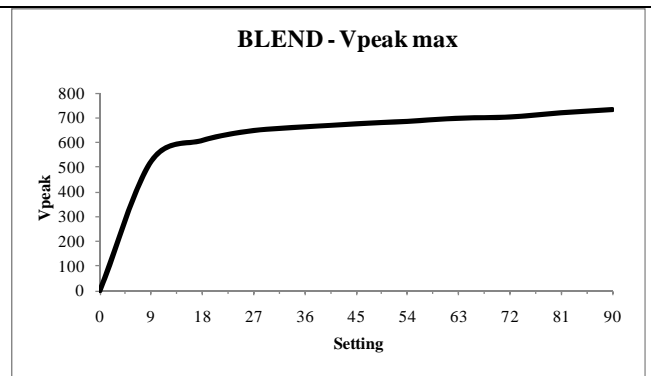

Diagrams of maximum mains voltage output versus Vp  
BLEND

**DIATERMO MB 120 F**

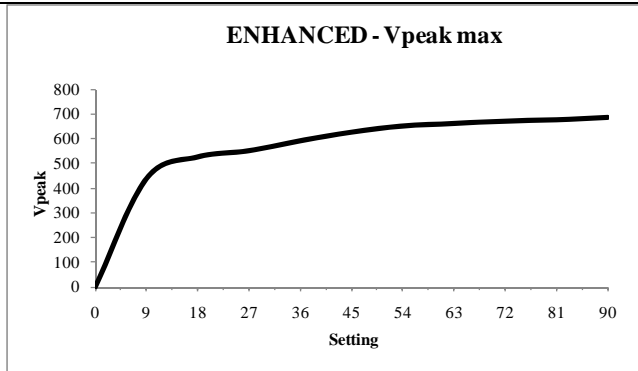

Diagrams of maximum mains voltage output versus Vp  
ENHANCED

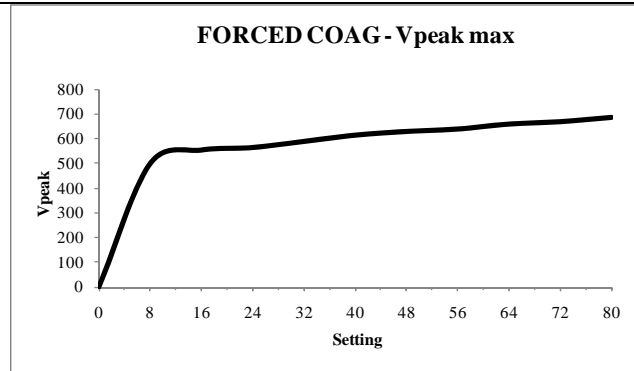

Diagrams of maximum mains voltage output versus Vp  
FORCED COAG

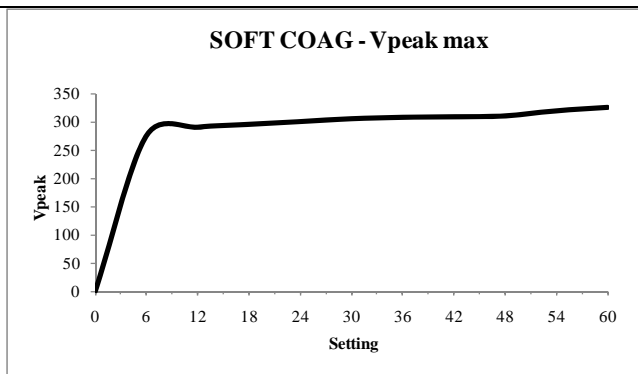

Diagrams of maximum mains voltage output versus Vp  
SOFT COAG

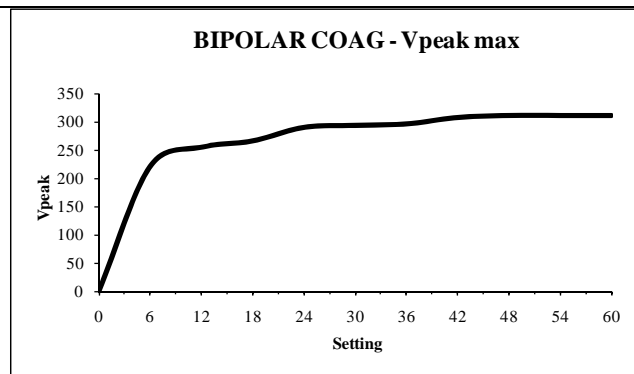

Diagrams of maximum mains voltage output versus Vp  
BIPOLAR COAG

**DIATERMO MB 200 F**

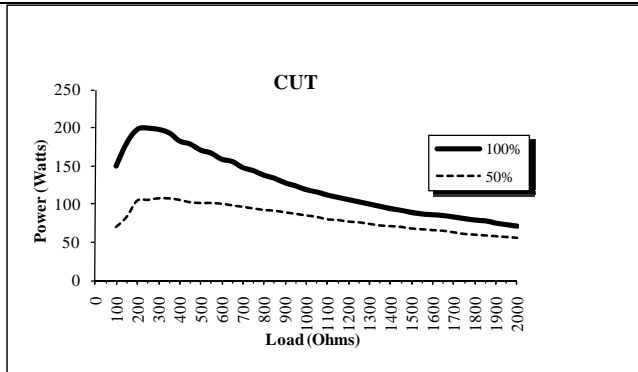

Diagrams of half and maximum output power versus impedance load  
100-2000Ω CUT 100%

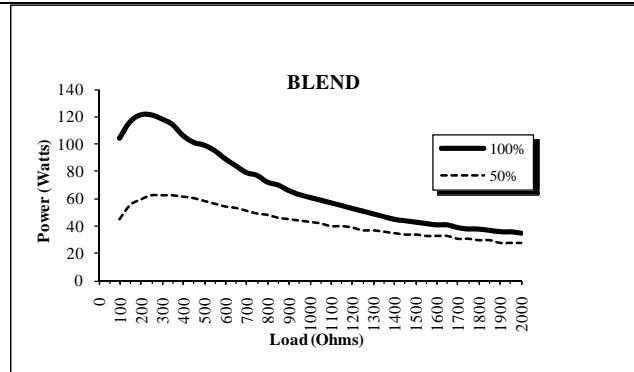

Diagrams of half and maximum output power versus impedance load  
100-2000Ω BLEND

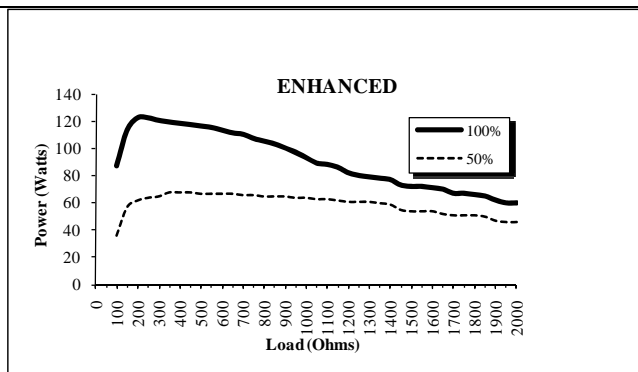

Diagrams of half and maximum output power versus impedance load 100-  
2000Ω ENHANCED

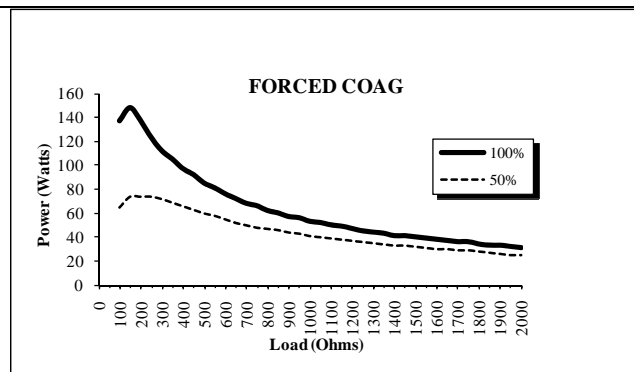

Diagrams of half and maximum output power versus impedance load 100-  
2000Ω FORCED COAG

DIATERMO MB 200 F

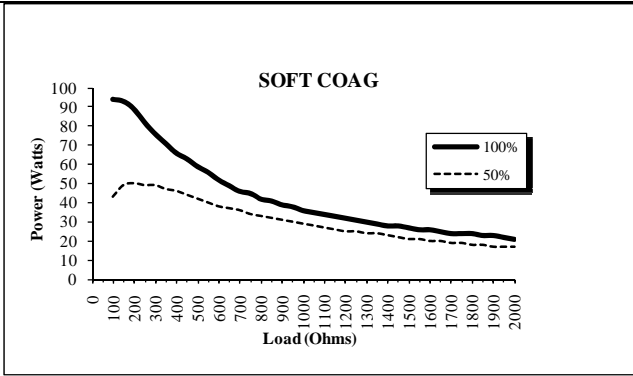

Diagrams of half and maximum output power versus impedance load 100-2000Ω SOFT COAG

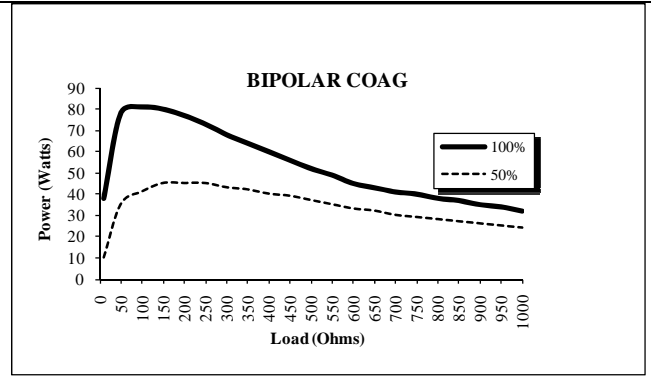

Diagrams of half and maximum output power versus impedance load 10-1000Ω BIPOLAR COAG

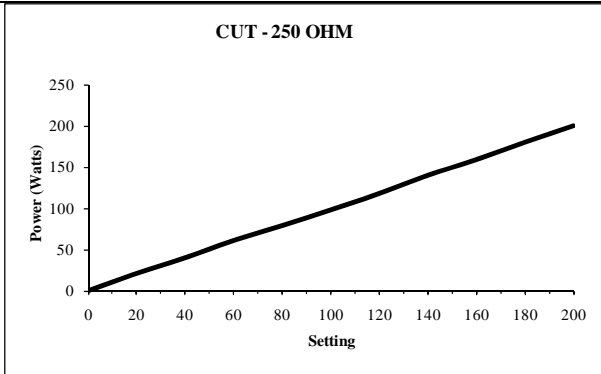

Diagrams of output power versus nominal value CUT100%

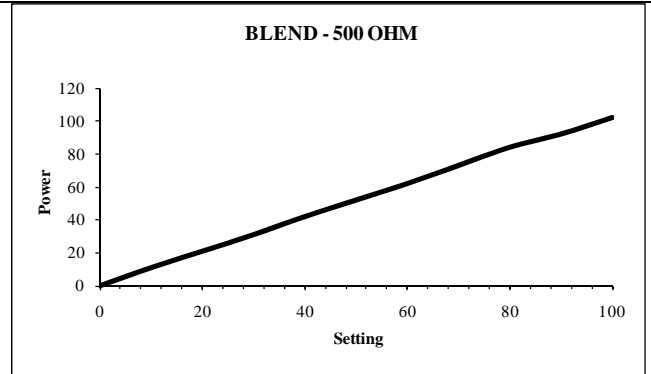

Diagrams of output power versus nominal value BLEND

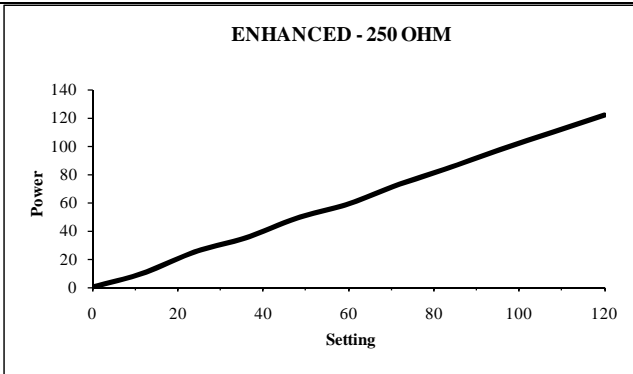

Diagrams of output power versus nominal value ENHANCED

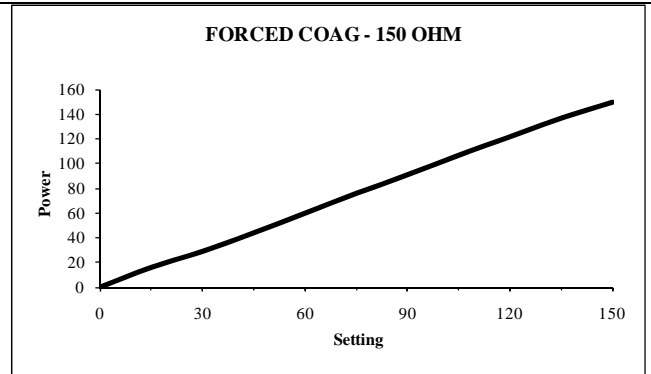

Diagrams of output power versus nominal value FORCED COAG

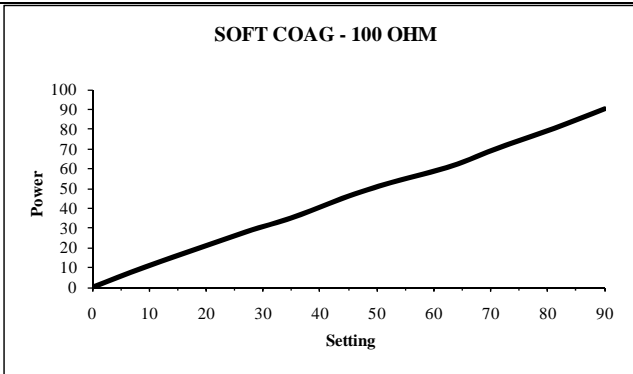

Diagrams of output power versus nominal value SOFT COAG

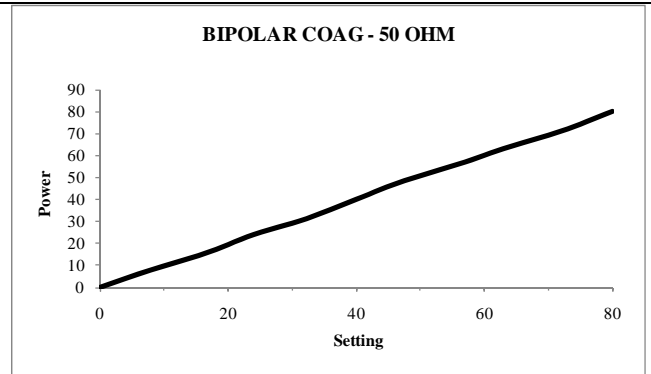

Diagrams of output power versus nominal value BIPOLAR COAG

DIATERMO MB 200 F

**CUT - Vpeak max**

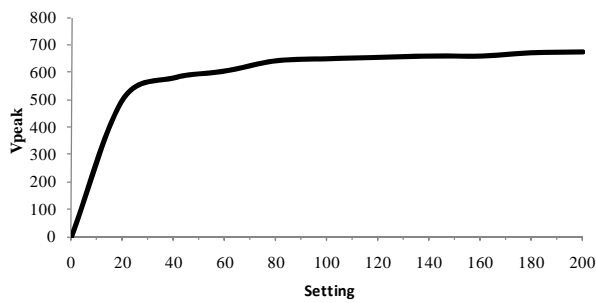

Diagrams of maximum mains voltage output versus Vp  
CUT100%

**BLEND - Vpeak max**

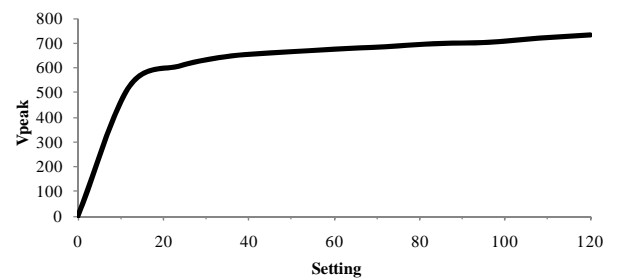

Diagrams of maximum mains voltage output versus Vp  
BLEND

**ENHANCED - Vpeak max**

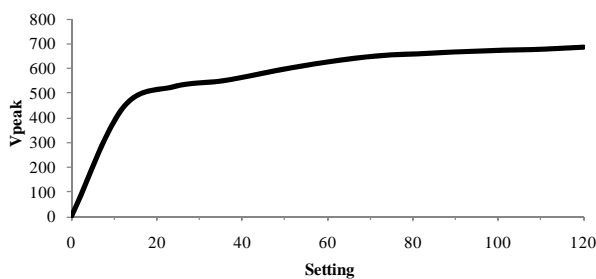

Diagrams of maximum mains voltage output versus Vp  
ENHANCED

**FORCED COAG - Vpeak max**

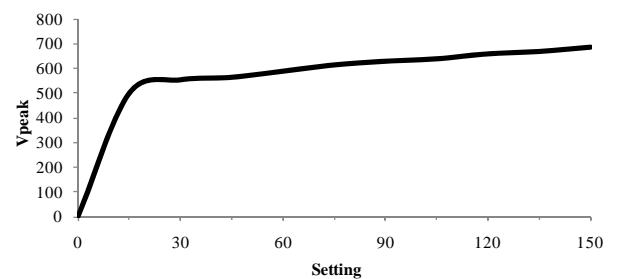

Diagrams of maximum mains voltage output versus Vp  
FORCED COAG

**SOFT COAG - Vpeak max**

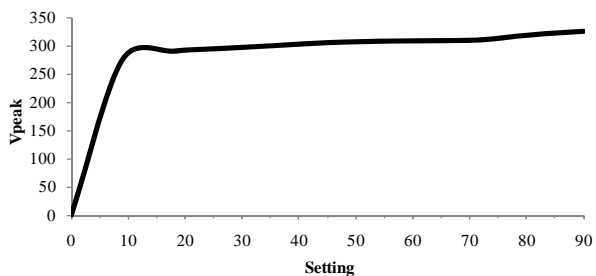

Diagrams of maximum mains voltage output versus Vp  
SOFT COAG

**BIPOLAR COAG - Vpeak max**

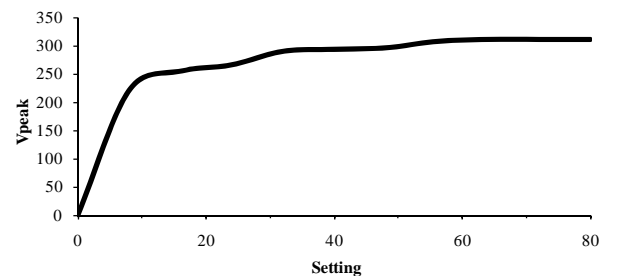

Diagrams of maximum mains voltage output versus Vp  
BIPOLAR COAG

**Information about elimination of this product  
(Applicable in the European Union and other European countries with  
separate collection systems)**

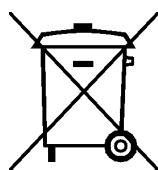

On the end of the life, the present product mustn't be eliminated as urban refusal, but it must be eliminated in a separated collection.

If the product is eliminated in unsuitable way, it is possible that some parts of the product (for example some accumulators) could be negative for the environment and for the human health.

The symbol on the side (barred dustbin on wheel) denotes that the products mustn't throw into urban refuses container but it must be eliminated with separate collection.

In case of abusive elimination of this product, could be foreseen sanctions.



