

# Status technical specification



**.mdd**

**.mdd has a leading position among manufacturers of office furniture with many awards that prove quality and continuously increase demand for it's products.**

The realities of today`s market require constant quality improvement at all levels of modern organization. This applies in particular to customer service, marketing, quality of products and also to quality of processes within the company.

Partnership relations among employees and with business partners form a base of economic growth and success of the company.

Constant investments in innovative machinery park, optimization of management systems and an expansion of production halls allow to minimize the lead times for the product of the highest quality.

**More than twenty years of experience in office furniture industry come with reference from a long list of companies and institutions to show their appreciation for an efficient and comprehensive service.**

**.mdd is higly aware of the environment.**

Being located in the forest region with lake by itis side, .mdd takes the nature seriously and invests constantly in a modern and energy-efficient solutions to preserve the local life. Company puts emphasis on waste segregation and recycling. .mdd has been awarded for the exceptional care and involvement in waste disposal. All materials used are environmentally friendly and enjoy a high 95 % rate of being recycled.



## General informations:

### Warranty:

.mdd products – **5 years.**

Electrical components and fabric – **2 years.**

### Certyficate - MFC:



### Compliant with standards:

PN-EN 527-2:2017-02

PN-EN 14073-2:2006

### Boards density:

12 mm – 690 – 750 kg/m<sup>3</sup>

18 mm – 650 – 690 kg/m<sup>3</sup>

28 mm – 610 – 630 kg/m<sup>3</sup>

36 mm – 610 – 630 kg/m<sup>3</sup>

### Assembly:

product delivered in separate elements

### Packing:

cardboard, perforated plastic mesh wrap

<b>Status</b>	Date of preparation 19.08.2021	The data contained in this document is valid in the day of its preparation. Change of the product, as long as it does not affect the basic features of it, does not require consistent updates of the document.	page 2/11
			<b>general informations</b>

**Desks**

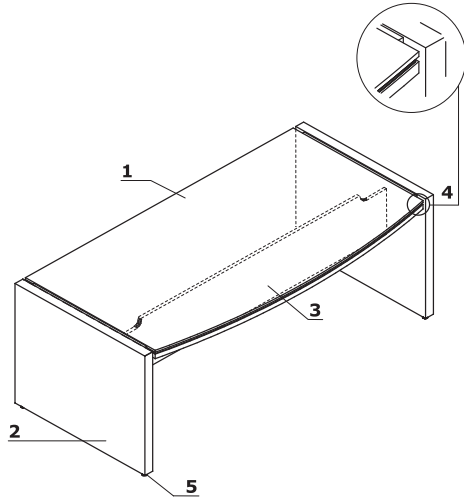

- 1. **Worktop** - MFC 52 mm (12+12+28 mm), ABS edge
- 2. **Base** - MFC 52 mm, ABS edge
- 3. **Modesty panel** - MFC 18 mm, ABS edge
- 4. **Thickening element** - MFC 12 mm, colour: 154 - anthracite
- 5. **Leveling** - 10 mm range

**Desk extensions**

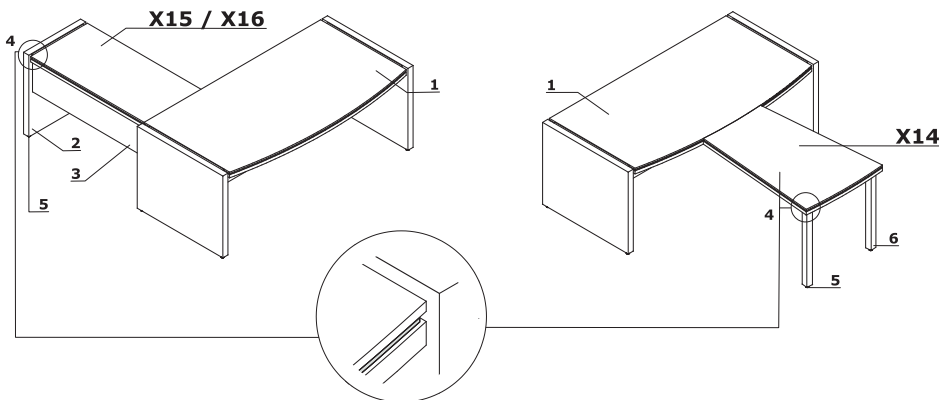

- 1. **Worktop** - MFC 52 mm (12+12+28 mm), ABS edge
- 2. **Base** - MFC 52 mm, ABS edge
- 3. **Modesty panel** - MFC 18 mm, ABS edge
- 4. **Thickening element** - MFC 12 mm, colour: 154 - anthracite
- 5. **Leveling** - 5 mm range
- 6. **Base** - MFC 61x61 mm, ABS edge

www.mdd.eu

ATTENTION - X14 front extension, X15 right extension, X16 left extension

**MFC base meeting tables**

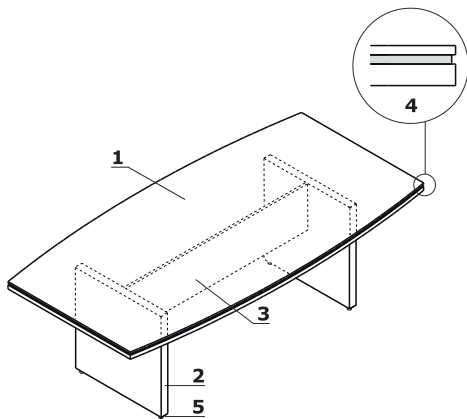

- 1. **Worktop** - MFC 52 mm (12+12+28 mm), ABS edge
- 2. **Base** - MFC 52 mm, ABS edge
- 3. **Modesty panel** - MFC 18 mm, ABS edge
- 4. **Thickening element** - MFC 12 mm, colour: 154 - anthracite
- 5. **Leveling** - 5 mm range

<p><b>Status</b></p>	<p>Date of preparation 19.08.2021</p>	<p>The data contained in this document is valid in the day of its preparation. Change of the product, as long as it does not affect the basic features of it, does not require consistent updates of the document.</p>	<p>page 3/11 <b>technical description</b></p>
----------------------	---	--	---

## Disc base meeting tables

1. **Worktop** - MFC 52 mm (12+12+28 mm), ABS edge
2. **Column** - powder coated steel
3. **Disc** - stainless steel
4. **Thickening element** - MFC 12 mm, colour: 154 - anthracite

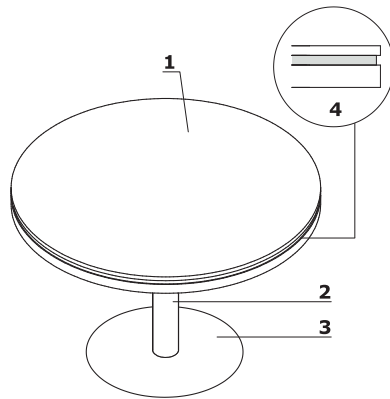

## Mobile pedestals

1. **Top** - MFC 12 mm, ABS edge
2. **Side panels** - MFC 28 mm, ABS edge
3. **Separate pencil drawer**
4. **Castors** - Ø50 mm, two with brakes
5. **Central lock** - foldable key
6. **Front** - MFC 18 mm, ABS edge
7. **Aluminum handle**
8. **Thickening element** - colour: M154 - anthracite semi-matt
9. **Suspension files drawer** - ball runners, max load 30 kg, 100% extraction

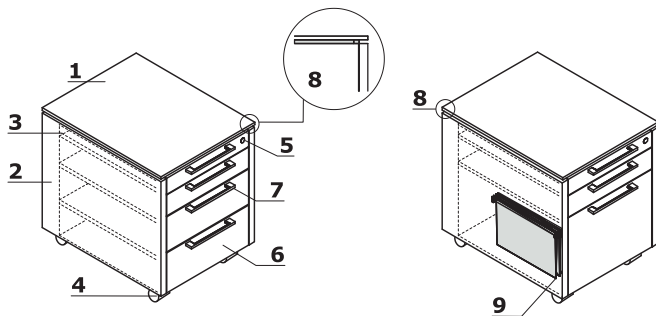

## Storages

1. **Top** - MFC 12 mm, ABS edge
2. **Side panels** - MFC 28 mm, ABS edge
3. **Base** - MFC 18 mm, ABS edge
4. **Glass front** - transparent tempered glass 5 mm
5. **Front** - MFC 18 mm, ABS edge, plain hinge 110°
6. **Body** - MFC 18 mm, colour: 154 - anthracite
7. **Aluminum handle**
8. **Thickening element** - colour: M154 - anthracite semi-matt

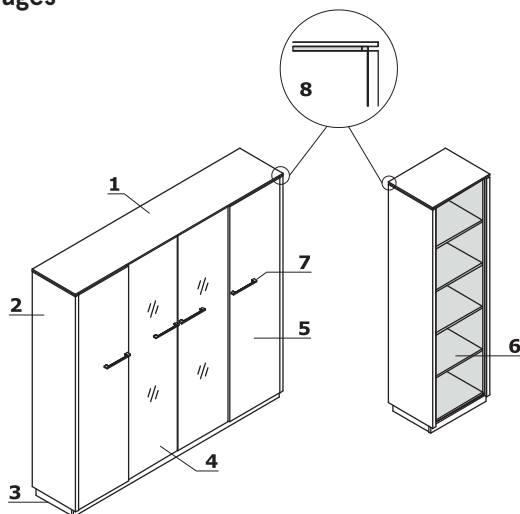

<p><b>Status</b></p>	<p>Date of preparation 19.08.2021</p>	<p>The data contained in this document is valid in the day of its preparation. Change of the product, as long as it does not affect the basic features of it, does not require consistent updates of the document.</p>	<p>page 4/11 <b>technical description</b></p>
----------------------	---	--	---

Possible mediaport location

- Mediaport S91E – location A, B (1pc);
- Mediaport S91E – 2x 230V, 2x RJ45

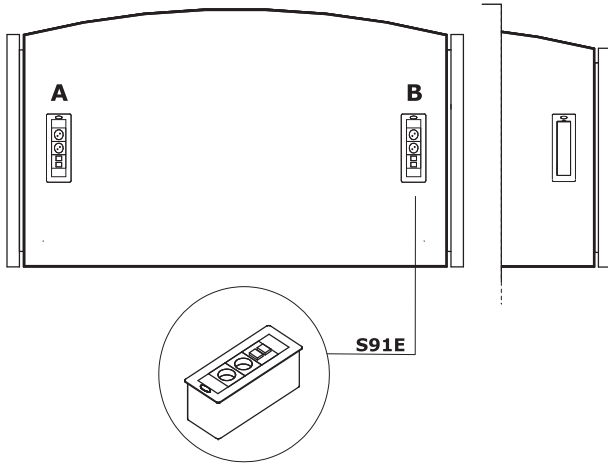

<b>Status</b>	Date of preparation 19.08.2021	The data contained in this document is valid in the day of its preparation. Change of the product, as long as it does not affect the basic features of it, does not require consistent updates of the document.	page 5/11 <b>technical description</b>
---------------	-----------------------------------	---	---

Possible mediaport location

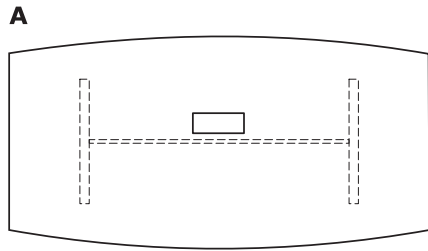

**X05**

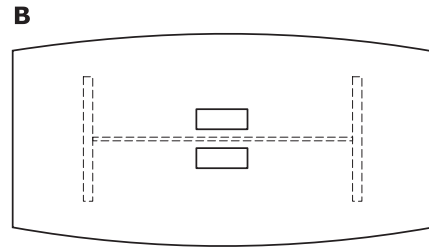

**X05**

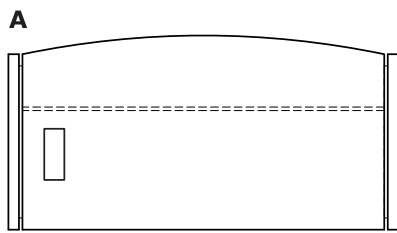

**X01 X02**

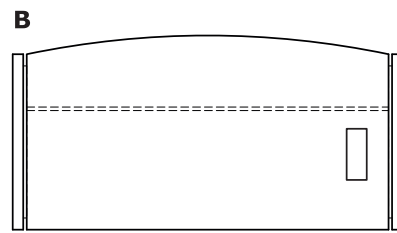

**X01 X02**

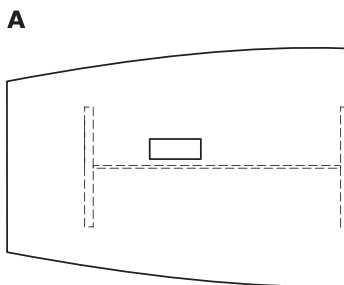

**X06**

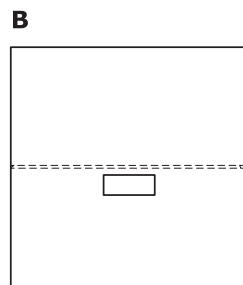

**X07**

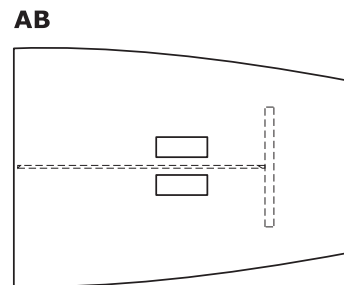

**X08**

**Desks \***

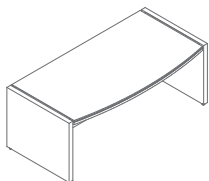

**X01**  
2000 / 900-1000 / 760  
99.1 kg

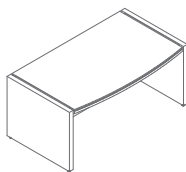

**X02**  
1700 / 900-970 / 760  
104.85 kg

**Desk extenstions \***

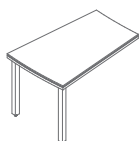

**X14**  
600-800 / 1200 / 760  
36.65 kg

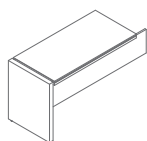

**X15**  
600 / 1270 / 760  
38.8 kg

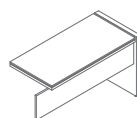

**X16**  
600 / 1270 / 760  
40 kg

**Pedestals \***

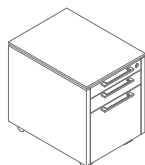

**XKD12**  
452 / 606 / 598  
35.4 kg

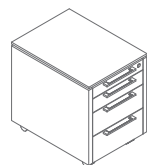

**XKD13**  
452 / 606 / 598  
55 kg

**Meeting tables \***



**X19**  
800 / 800 / 550  
34.05 kg



**X22**  
800 / 800 / 760  
40.3 kg



**X120**  
1200 / 1200 / 756  
71.75 kg

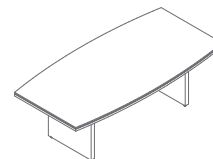

**X05**  
2400 / 1000-1200 / 760  
140.45 kg

\* dimensions expressed in millimeters: width x depth x height

<b>Status</b>	Date of preparation 19.08.2021	The data contained in this document is valid in the day of its preparation. Change of the product, as long as it does not affect the basic features of it, does not require consistent updates of the document.	page 7/11
			<b>products</b>

Meeting tables \*

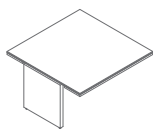

**X07**  
1400 / 1400 / 760  
93.4 kg

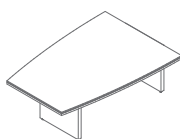

**X06**  
2000 / 1000-1400 / 760  
127.5 kg

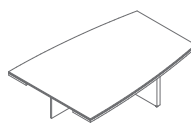

**X08**  
2000 / 1000-1400 / 760  
116 kg

Conference table \*

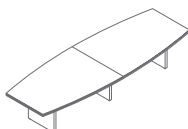

**X09**  
4000 / 1400-1000 / 760  
239.7 kg

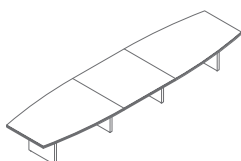

**X10**  
5400 / 1400-1000 / 760  
331.2 kg

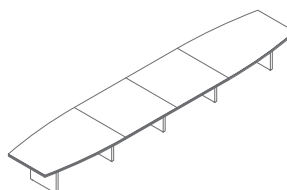

**X11**  
6800 / 1400-1000 / 760  
422.7 kg

Storages \*



**X26**  
544 / 421 / 820  
44.1 kg



**X27**  
544 / 421 / 820  
445.05 kg



**X36**  
544 / 421 / 1167  
61.5 kg



**X37**  
544 / 421 / 1167  
60.95 kg



**X56**  
544 / 421 / 1871  
90.15 kg



**X57**  
544 / 421 / 1871  
90.2 kg

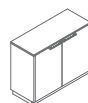

**X21**  
1032 / 421 / 820  
69.95 kg

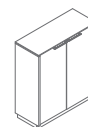

**X31**  
1032 / 421 / 1167  
94.5 kg

\* dimensions expressed in millimeters: width x depth x height

<b>Status</b>	Date of preparation 19.08.2021	The data contained in this document is valid in the day of its preparation. Change of the product, as long as it does not affect the basic features of it, does not require consistent updates of the document.	page 8/11
			<b>products</b>



Storages \*

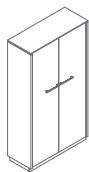

**X51**  
1032 / 421 / 1871  
142.4 kg

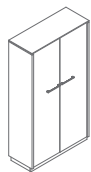

**X52**  
1032 / 421 / 1871  
1231 kg

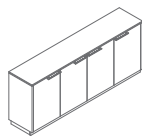

**X2167**  
2008 / 421 / 820  
130.25 kg

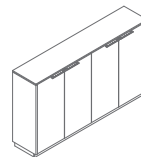

**X311**  
2008 / 421 / 1167  
168.65 kg



**X35**  
1032 / 421 / 1167  
95.9 kg

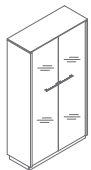

**X55**  
1032 / 421 / 1871  
143.2 kg

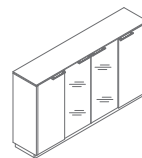

**X3567**  
2008 / 421 / 1167  
177.5 kg

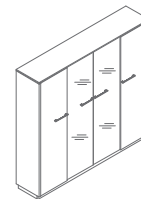

**X5567**  
2008 / 421 / 1167  
3262.5 kg

Bookcases \*



**X39**  
544 / 421 / 1167  
53.05 kg

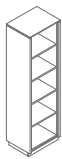

**X59**  
544 / 421 / 1871  
79.05 kg

Half bookcases \*

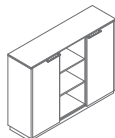

**X3679**  
1520 / 421 / 1167  
134.65 kg

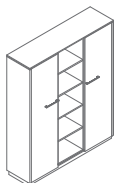

**X5679**  
1520 / 421 / 1871  
198.35 kg

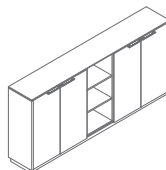

**X3119**  
2496 / 421 / 1167  
201.1 kg

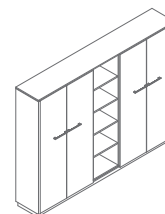

**X5119**  
2496 / 421 / 1871  
302.7 kg

\* dimensions expressed in millimeters: width x depth x height

Half bookcases \*

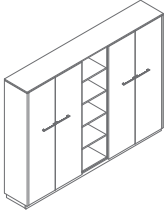

**X5129**

2496 / 421 / 1871  
291.3 kg

Accessories \*

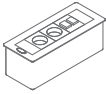

**S91E**

267 / 110 / 93  
1.9 kg

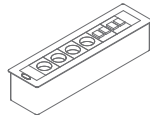

**S92E**

426 / 110 / 93  
2.75 kg

\* dimensions expressed in millimeters: width x depth x height

<b>Status</b>	Date of preparation 19.08.2021	The data contained in this document is valid in the day of its preparation. Change of the product, as long as it does not affect the basic features of it, does not require consistent updates of the document.	page 10/11
			<b>products</b>

MFC elements



31 Canadian oak



106 Lowland walnut



167 Grey oak



168 Natural oak

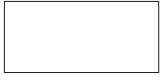

67 White pastel

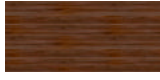

171 Dark walnut

Spacer



154 Anthracite

Tables - disc base - column



M009 Aluminum semi-matt RAL9006



M015 White semi-matt RAL9010



M115 Black semi-matt RAL9005