

Work happily



V1.0

naggura'swop

naggura.com

Our products



S703LB S703DB



The Swop 703 is an electrical 3-section couch with a one-piece mattress and wooden structure.

Wood, Metal or Pmma



Collections

Nordic
METAL

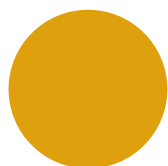

Yellow

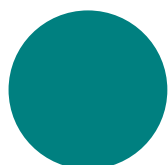

Blue

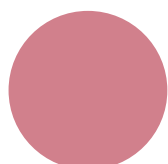

Pink

Foll
METAL

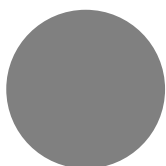

Ash

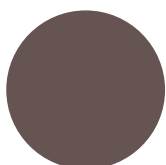

Clay

Iron
METAL

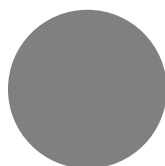

Inox

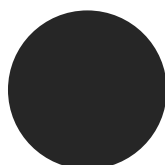

Black

Om
WOOD



Oak



Wenge

Techno
PMMA



Fluor

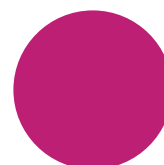

Fuxia



Ice

S703

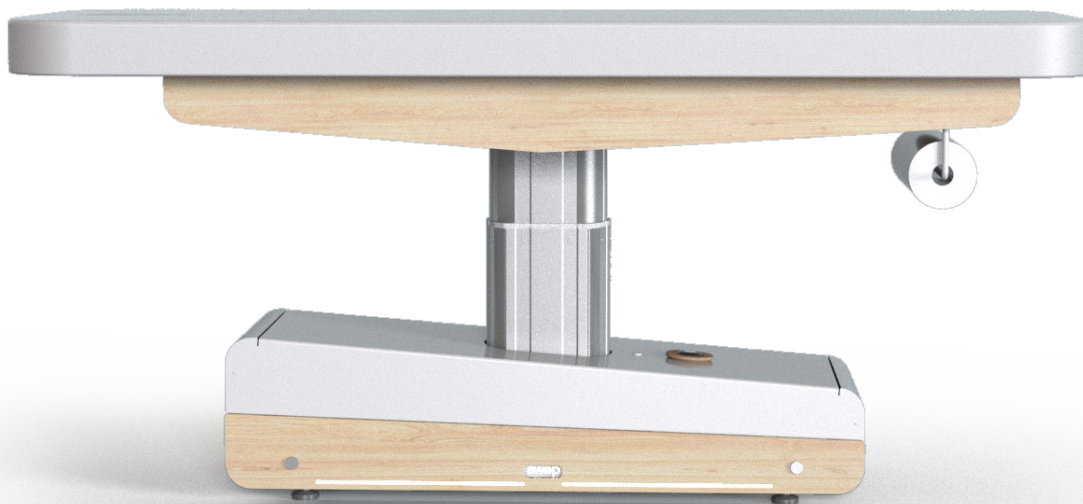

S703LB



S703DB

Dimensions

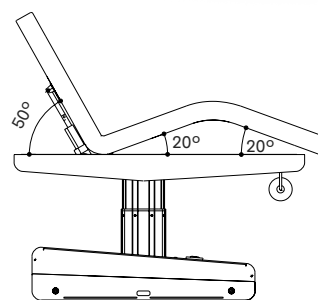
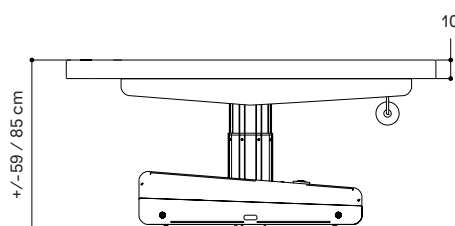
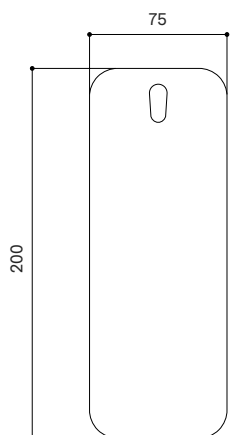

General Specifications

MOTORS 3 engine (height, footrest, backrest)
DIMENSIONS (LENGTH X WIDTH) 200 x 75 cm
HEIGHT (MIN. AND MAX.) 59/85 cm
WEIGHT 110 kg

THICKNESS 10 cm
DENSITY 30 kg/m ³
LIFTING CAPACITY 175 kg
OPERATION Hand controller (included)/ Foot controller (optional)

POWER SUPPLY 230 V - 50/60 Hz
MAX. INTENSITY 2 A
ELECTRIC MOTOR 6.000 N

CUSHION Upholstery Seamless round edges 100% Vinyl-compound Permaguard 3 advanced vinyl protection (against germs and stains), UV re- sistant, superior abrasion 100K
--