

TECHNICAL SPECIFICATION

COLOURS

FABRIC PANEL, VERTICAL PANEL FOR BENCH DESKS - SONIC, TWIN - FABRIC NEMO

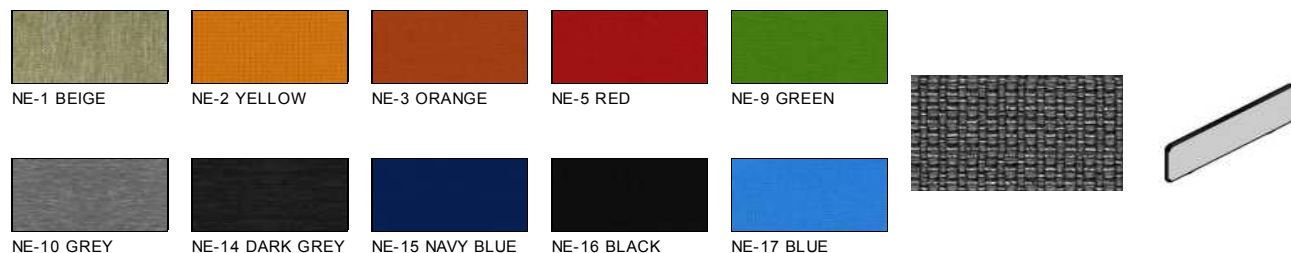

FABRIC PANEL, VERTICAL PANEL FOR BENCH DESKS - SONIC, TWIN - FABRIC RUNNER - SECOND GROUP



FABRIC PANEL, VERTICAL PANEL FOR BENCH DESKS - SONIC, TWIN - FABRIC MEDLEY - SECOND GROUP

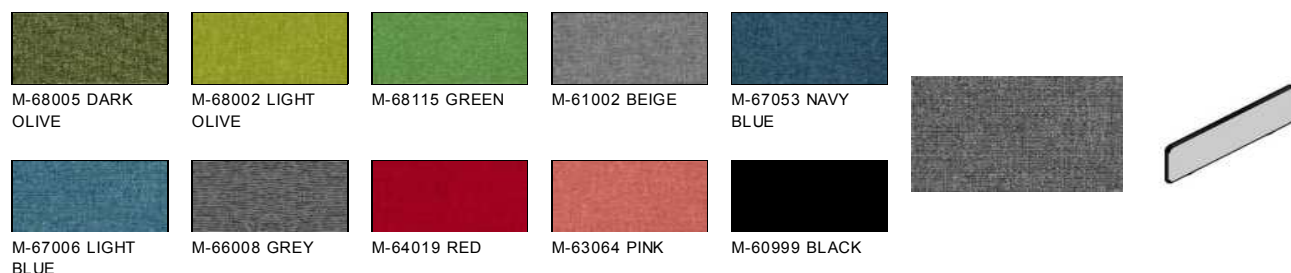

FABRIC PANEL, VERTICAL PANEL FOR BENCH DESKS - SONIC, TWIN - FABRIC ATLANTIC - SECOND GROUP



FABRIC PANEL, VERTICAL PANEL FOR BENCH DESKS - SONIC, TWIN - FABRIC XTREME - THIRD PRICE GROUP



TECHNICAL SPECIFICATION

COLOURS

FABRIC PANEL, VERTICAL PANEL FOR BENCH DESKS - SONIC, TWIN - FABRIC SYNERGY - THIRD PRICE GROUP



FABRIC PANEL - FABRIC NEMO

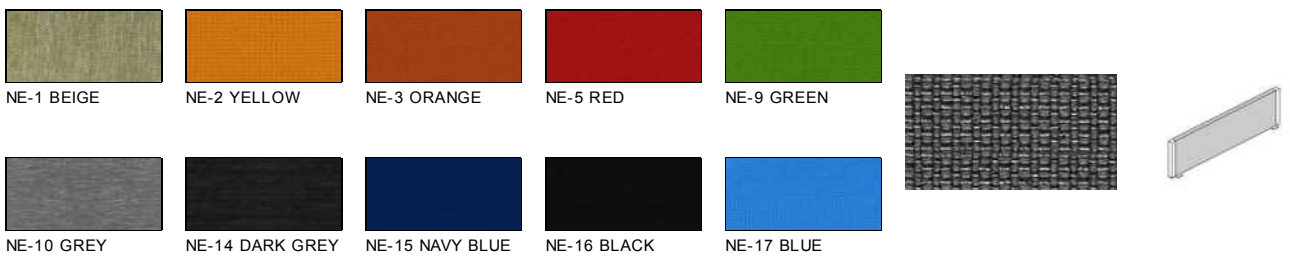

FRAME



MODESTY PANELS



METAL MODESTY PANEL



TECHNICAL SPECIFICATION

PANELS

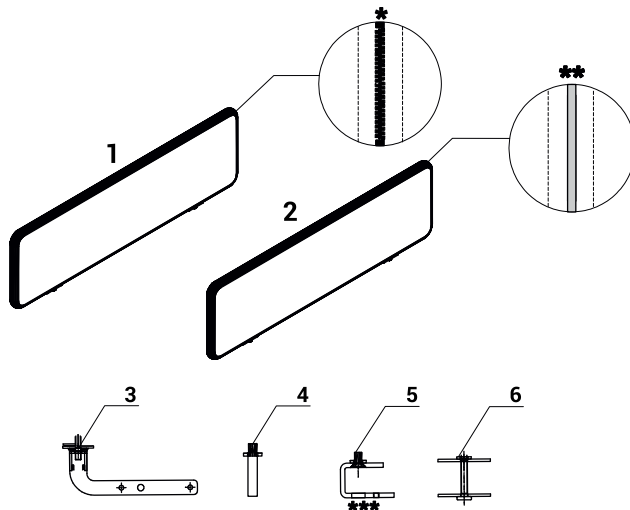

1. **Sonic Panel** - acoustic class A, fire resistant, zip fastener, pinable
2. **Twin Panel** - fire resistant, pinable
3. **YAN** - panel fixing for single desks (Option with additional charge), colour: M009 - aluminum semi-matte, M015 - metal white semi-matte, M154 - anthracite semi-matte
4. **YAN** - brackets for benches included, colour: M009 - aluminum semi-matte, M015 - metal white semi-matte, M154 - anthracite semi-matte
5. **OGI, ERGONOMIC MASTER, ALFA** - panel fixing for single desks (option with additional charge), colour: M009 - aluminum semi-matte, M015 - metal white semi-matte, M154 - anthracite semi-matte
6. **OGI** - brackets for benches included, colour: M009 - aluminum semi-matte, M015 - metal white semi-matte, M154 - anthracite semi-matte

\* Zip in graphite colour - no unzipping \*\* Ornament - plastic strap in gray colour \*\*\* Fixing for 16 - 30mm tops

TWIN - FABRIC PANELS FOR BENCH DESKS

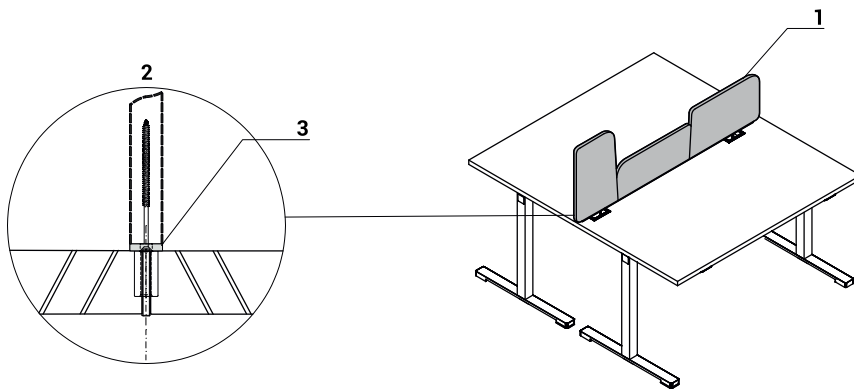

1. **Fire resistant** - pinable
2. **Fixing element** - powder coated metal, colour: M009 - aluminum semi-matte
3. **Fixing strip** - metal powder coated, colour: M009 - aluminum semi-matte

SIDE PANELS

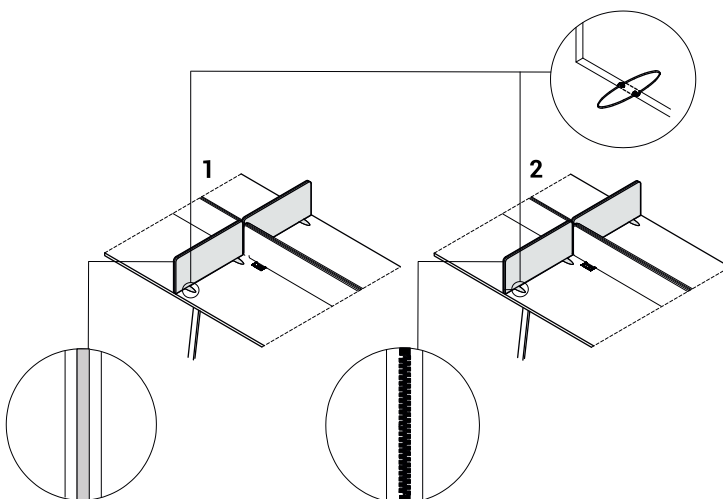

1. **Twin Panel** - fire resistant fabric, pinnable, strip colour: aluminium, fixing colour: M009 - aluminum semi-matte, M015 - white semi-matte, M154 - anthracite semi-matte
2. **Sonic Panel** - acoustic class A, fire resistant fabric, pinnable, zip color - graphite, fixings colour: M009 - aluminum semi-matte, M015 - white semi-matte, M154 - anthracite semi-matte

TECHNICAL SPECIFICATION

SIDE PANELS FOR YAN BENCH DESKS

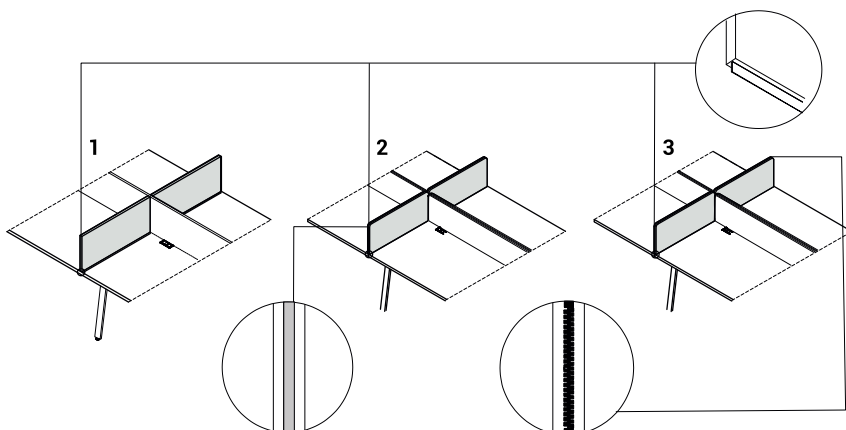

1. **MFC panel** - MFC 18mm,
2. **Twin Panel** - fire resistant fabric, pinnable, strip colour: aluminum, fixing colours: M009 - aluminum semi-matte, M015 - white semi-matte, M154 - anthracite semi-matte
3. **Sonic Panel** - acoustic class A, fire resistant fabric, pinnable, zip colour - graphite, fixings colours: M009 - aluminum semi-matte, M015 - white semi-matte, M154 - anthracite semi-matte

ACCESSORIES FOR FUNCTION RAIL

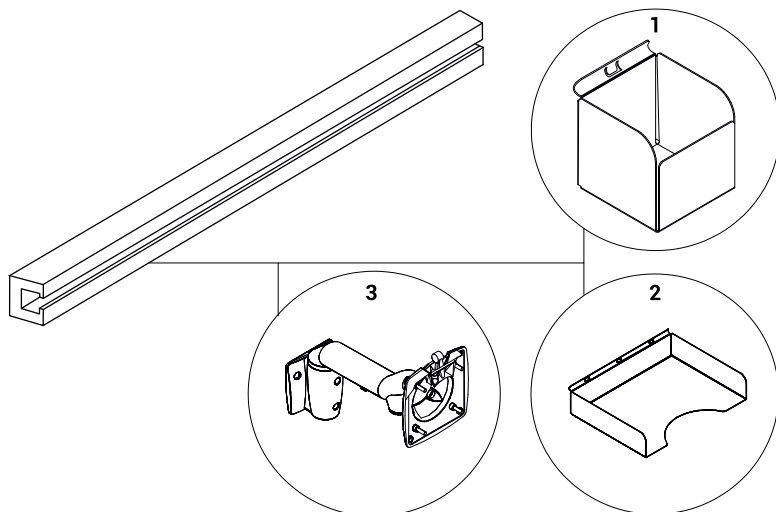

1. **Organizer** - powder painted metal
2. **Shelf** - A4 size, powder painted steel
3. **Monitor holder** - powder painted steel, colour: M009 - aluminum semi-matte

ATTENTION: Only accessories from MDD offer can be mounted

SONIC PANELS FOR SINGLE DESKS

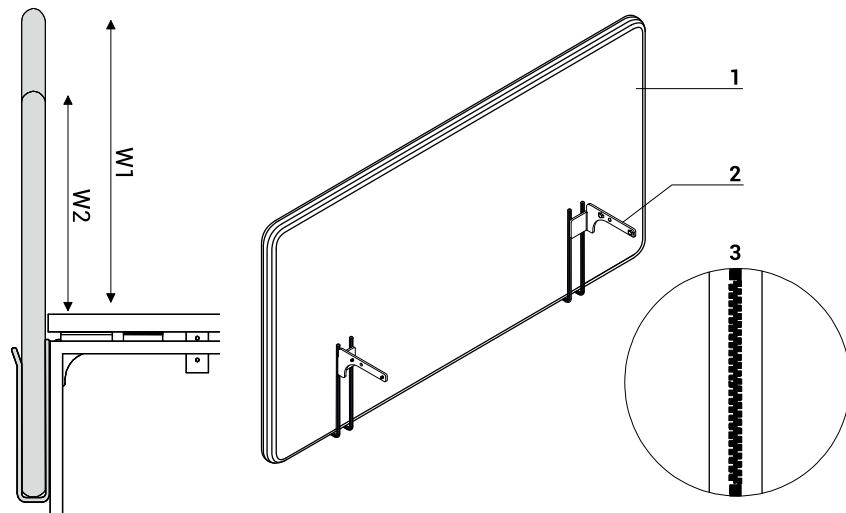

1. **Fire resistant** - acoustic class A, pinable
2. **Fixing element** - powder coated metal, colour: M009 - aluminum semi-matte, M015 - metal white semi-matte, M154 - anthracite semi-matte
3. **Zip fastener**

W1 - 507mm | W2 - 357mm

## TECHNICAL SPECIFICATION

### SONIC - SIDE PANELS

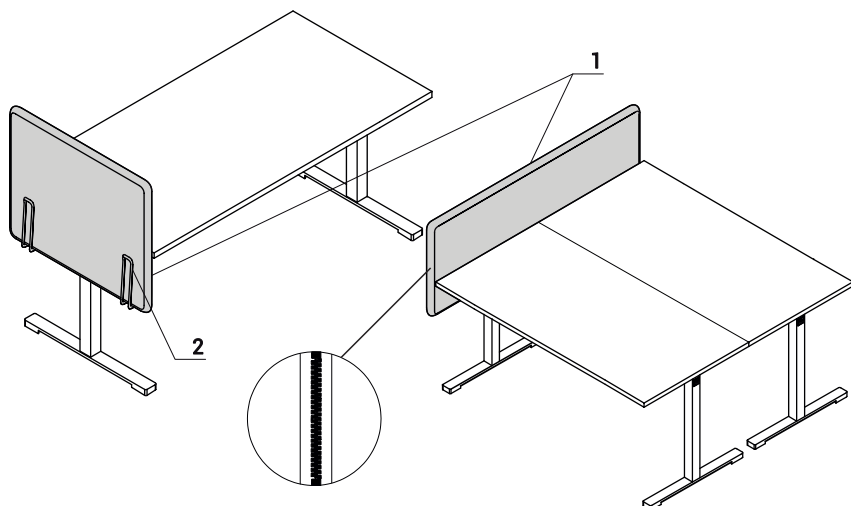

### FABRIC PANELS

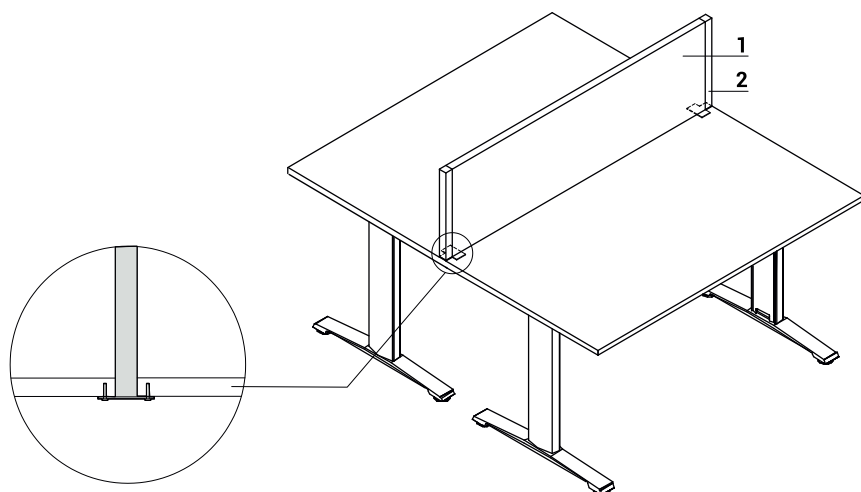

ATTENTION – assembly possible only for desks ERGONOMIC MASTER and ALFA

### MODESTY PANELS

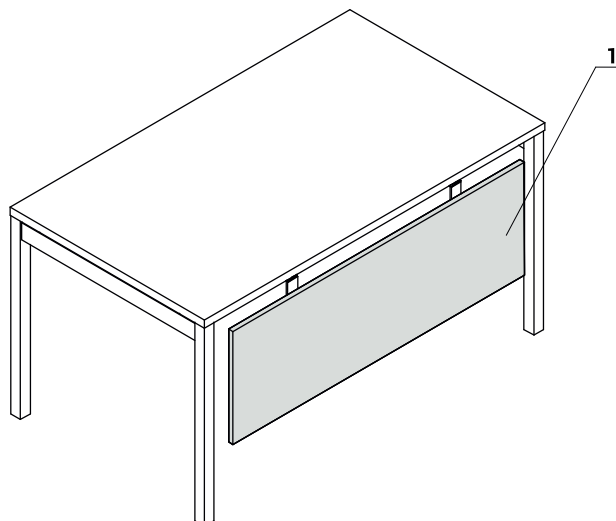

**TECHNICAL SPECIFICATION**  
**MODESTY PANELS**

1. Metal modesty panel, fixings included

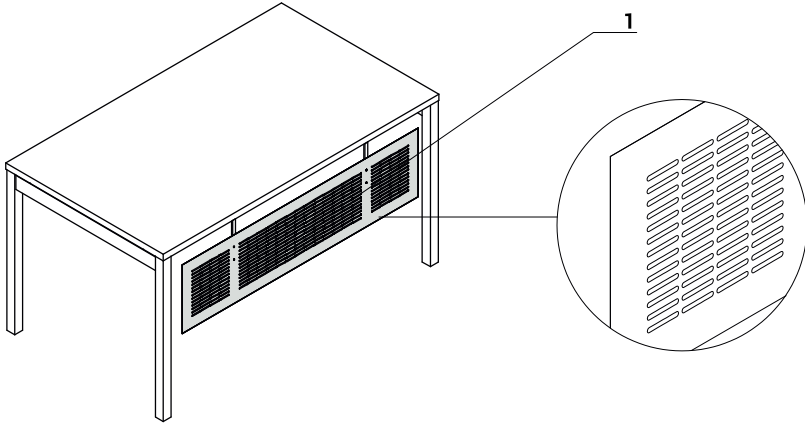

ATTENTION - not for YAN desks

---

PRODUCT ILLUSTRATION	DIMENSIONS [mm]			INDEX SYMBOL						COMMENTS
	WIDTH	DEPTH	HEIGHT			kg	m3	pcs		

**TWIN - FABRIC PANELS**

	1190	30	350	<b>ZUT12</b>		7.1	0.019	2		for 1200mm wide desks; YAN desks only with square grommets; Possibility of fixing to single desks - additional fee applies
	1390	30	350	<b>ZUT14</b>		10.0	0.021	2		for 1400mm wide desks; YAN desks only with square grommets; Possibility of fixing to single desks - additional fee applies
	1590	30	350	<b>ZUT16</b>		9.5	0.024	2		for 1600mm wide desks; YAN desks only with square grommets; Possibility of fixing to single desks - additional fee applies
	1790	30	350	<b>ZUT18</b>		12.0	0.027	2		for 1800mm wide desks; YAN desks only with square grommets; Possibility of fixing to single desks - additional fee applies
	1990	30	350	<b>ZUT20</b>		12.5	0.029	2		for 2000mm wide desks; YAN desks only with square grommets; Possibility of fixing to single desks - additional fee applies
	1190	30	450 350	<b>ZUT22</b>		10.0	0.021	2		for 1200mm wide desks; YAN desks only with square grommets; Possibility of fixing to single desks - additional fee applies
	1390	30	450 350	<b>ZUT24</b>		11.0	0.025	2		for 1400mm wide desks; YAN desks only with square grommets; Possibility of fixing to single desks - additional fee applies
	1590	30	450 350	<b>ZUT26</b>		12.0	0.028	2		for 1600mm wide desks; YAN desks only with square grommets; Possibility of fixing to single desks - additional fee applies
	1790	30	450 350	<b>ZUT28</b>		13.0	0.035	2		for 1800mm wide desks; YAN desks only with square grommets; Possibility of fixing to single desks - additional fee applies

**ADDITIONAL CHARGE**



FEATURE	PRODUCT												COMMENTS
	ZUT12	ZUT14	ZUT16	ZUT18	ZUT20	ZUT22	ZUT24	ZUT26	ZUT28	kg	m3	pcs	
BRACKET TO SINGLE DESK										0.1	0.0001	1	
II PRICE GROUP										0.0	0.0000	0	
III PRICE GROUP										1.0	0.0010	1	
HANGING RAIL (1 PC.)										1.0	0.0010	1	
HANGING RAIL (2 PC.)										1.0	0.0010	1	

DESCRIPTION



- NET WEIGHT

VOLUME

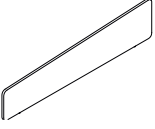

NUMBER OF PACKAGES

PRODUCT ILLUSTRATION	DIMENSIONS [mm]			INDEX SYMBOL						COMMENTS
	WIDTH	DEPTH	HEIGHT			kg	m3	pcs		

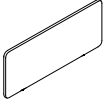
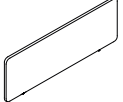
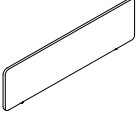
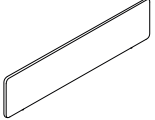
**TWIN - FABRIC PANELS**

	1990	30	450 350	<b>ZUT29</b>		14.0	0.039	2		for 2000mm wide desks; YAN desks only with square grommets; Possibility of fixing to single desks - additional fee applies
	1190	30	500	<b>ZUT52</b>		9.5	0.024	2		for 1200mm wide desks; YAN desks only with square grommets; Possibility of fixing to single desks - additional fee applies
	1390	30	500	<b>ZUT54</b>		11.5	0.028	2		for 1400mm wide desks; YAN desks only with square grommets; Possibility of fixing to single desks - additional fee applies
	1590	30	500	<b>ZUT56</b>		12.5	0.031	2		for 1600mm wide desks; YAN desks only with square grommets; Possibility of fixing to single desks - additional fee applies
	1790	30	500	<b>ZUT58</b>		14.0	0.035	2		for 1800mm wide desks; YAN desks only with square grommets; Possibility of fixing to single desks - additional fee applies
	1990	30	500	<b>ZUT59</b>		15.5	0.039	2		for 2000mm wide desks; YAN desks only with square grommets; Possibility of fixing to single desks - additional fee applies

**ADDITIONAL CHARGE**

FEATURE	PRODUCT										COMMENTS
	ZUT29	ZUT52	ZUT54	ZUT56	ZUT58	ZUT59		kg	m3	pcs	
BRACKET TO SINGLE DESK								0.1	0.0001	1	
II PRICE GROUP								0.0	0.0000	0	
III PRICE GROUP								1.0	0.0010	1	
HANGING RAIL (1 PC.)								1.0	0.0010	1	
HANGING RAIL (2 PC.)								1.0	0.0010	1	

DESCRIPTION

 - NET WEIGHT

 VOLUME

 NUMBER OF PACKAGES



PRODUCT ILLUSTRATION	DIMENSIONS [mm]			INDEX SYMBOL						COMMENTS
	WIDTH	DEPTH	HEIGHT			kg	m3	pcs		

TWIN - FABRIC PANELS FOR BENCH DESKS

	1190	30	360	ZUT32		7.0	0.024	1		for 1200mm wide desks; YAN desks only with square grommets
	1390	30	360	ZUT34		7.5	0.018	1		for 1400mm wide desks; YAN desks only with square grommets
	1590	30	560	ZUT36		12.0	0.033	1		for 1600mm wide desks; YAN desks only with square grommets
	1790	30	560	ZUT38		13.0	0.037	1		for 1800mm wide desks; YAN desks only with square grommets
	1590	30	560	ZUT46		10.0	0.033	1		for 1600mm wide desks; YAN desks only with square grommets
	1790	30	560	ZUT48		12.0	0.037	1		for 1800mm wide desks; YAN desks only with square grommets

ADDITIONAL CHARGE



FEATURE	PRODUCT										COMMENTS
	ZUT32	ZUT34	ZUT36	ZUT38	ZUT46	ZUT48		kg	m3	pcs	
II PRICE GROUP								0.0	0.0000	0	
III PRICE GROUP								1.0	0.0010	1	

DESCRIPTION



- NET WEIGHT

VOLUME

NUMBER OF PACKAGES

PRODUCT ILLUSTRATION	DIMENSIONS [mm]			INDEX SYMBOL						COMMENTS
	WIDTH	DEPTH	HEIGHT			kg	m3	pcs		

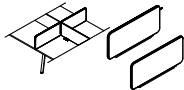
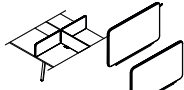
TWIN - VERTICAL FABRIC PANELS FOR BENCH DESKS

	1600	30	350	ZYT78		12.0	0.014	2		for YAN bench desks (set od 2 pcs)
	1600	30	500	ZYT79		12.0	0.021	2		for YAN bench desks (set od 2 pcs)
	777	30	350	ZOT78		4.2	0.007	1		for OGI bench desks (1 pc)
	777	30	500	ZOT79		6.0	0.010	1		for OGI bench desks (1 pc)

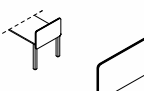
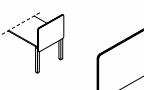

TWIN - PANELS FOR SINGLE DESK

	800	30	500	ZUT30		0.0	0.001	0		
	800	30	650	ZUT50		0.0	0.001	0		

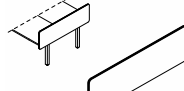
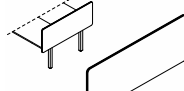
TWIN - PANELS FOR BENCH

	1600	30	500	ZUT31		0.0	0.001	0		
	1600	30	650	ZUT51		0.0	0.001	0		

ADDITIONAL CHARGE



FEATURE	PRODUCT												COMMENTS
	ZYT78	ZYT79	ZOT78	ZOT79	ZUT30	ZUT50	ZUT31	ZUT51		kg	m3	pcs	
II PRICE GROUP										0.0	0.0000	0	
III PRICE GROUP										1.0	0.0010	1	

DESCRIPTION









 - NET WEIGHT

 VOLUME



 NUMBER OF PACKAGES

PRODUCT ILLUSTRATION	DIMENSIONS [mm]			INDEX SYMBOL						COMMENTS
	WIDTH	DEPTH	HEIGHT			kg	m3	pcs		

**SONIC ACOUSTIC PANELS**

	1190	40	350	<b>ZUS12</b>		9.0	0.024	2		for 1200mm wide desks; YAN desks only with square grommets; Possibility of fixing to single desks - additional fee applies
	1390	40	350	<b>ZUS14</b>		11.0	0.028	2		for 1400mm wide desks; YAN desks only with square grommets; Possibility of fixing to single desks - additional fee applies
	1590	40	350	<b>ZUS16</b>		12.0	0.032	2		for 1600mm wide desks; YAN desks only with square grommets; Possibility of fixing to single desks - additional fee applies
	1790	40	350	<b>ZUS18</b>		13.0	0.035	2		for 1800mm wide desks; YAN desks only with square grommets; Possibility of fixing to single desks - additional fee applies
	1990	40	350	<b>ZUS20</b>		14.0	0.039	2		for 2000mm wide desks; YAN desks only with square grommets; Possibility of fixing to single desks - additional fee applies
	1190	40	500	<b>ZUS52</b>		9.0	0.033	2		for 1200mm wide desks; YAN desks only with square grommets; Possibility of fixing to single desks - additional fee applies
	1390	40	500	<b>ZUS54</b>		11.0	0.039	2		for 1400mm wide desks; YAN desks only with square grommets; Possibility of fixing to single desks - additional fee applies
	1590	40	500	<b>ZUS56</b>		12.0	0.047	2		for 1600mm wide desks; YAN desks only with square grommets; Possibility of fixing to single desks - additional fee applies
	1790	40	500	<b>ZUS58</b>		13.0	0.049	2		for 1800mm wide desks; YAN desks only with square grommets; Possibility of fixing to single desks - additional fee applies

**ADDITIONAL CHARGE**



FEATURE	PRODUCT													COMMENTS
	ZUS12	ZUS14	ZUS16	ZUS18	ZUS20	ZUS52	ZUS54	ZUS56	ZUS58		kg	m3	pcs	
BRACKET TO SINGLE DESK											0.1	0.0001	1	
II PRICE GROUP											0.0	0.0000	0	
III PRICE GROUP											1.0	0.0010	1	
HANGING RAIL (1 PC.)											1.0	0.0010	1	
HANGING RAIL (2 PC.)											1.0	0.0010	1	

DESCRIPTION

 - NET WEIGHT

 VOLUME

 NUMBER OF PACKAGES

PRODUCT ILLUSTRATION	DIMENSIONS [mm]			INDEX SYMBOL						COMMENTS
	WIDTH	DEPTH	HEIGHT			kg	m3	pcs		



**SONIC ACOUSTIC PANELS**

	1990	40	500	<b>ZUS59</b>		14.0	0.054	2		for 2000mm wide desks; YAN desks only with square grommets; Possibility of fixing to single desks - additional fee applies
---	------	----	-----	--------------	--	------	-------	---	--	--

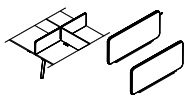
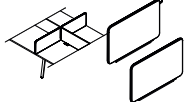
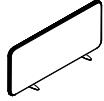
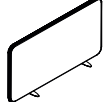
**SONIC - VERTICAL ACOUSTIC PANELS FOR BENCH DESKS**

	1600	40	350	<b>ZYS78</b>		12.0	0.030	2		for YAN bench desks (set of 2 pcs)
	1600	40	500	<b>ZYS79</b>		8.0	0.042	2		for YAN bench desks (set of 2 pcs)
	780	40	350	<b>ZOS78</b>		3.3	0.015	1		for OGI bench desks
	780	40	500	<b>ZOS79</b>		4.0	0.021	1		for OGI bench desks

**ADDITIONAL CHARGE**



FEATURE	PRODUCT													COMMENTS
	ZUS59	ZYS78	ZYS79	ZOS78	ZOS79						kg	m3	pcs	
BRACKET TO SINGLE DESK											0.1	0.0001	1	
II PRICE GROUP											0.0	0.0000	0	
III PRICE GROUP											1.0	0.0010	1	
HANGING RAIL (1 PC.)											1.0	0.0010	1	
HANGING RAIL (2 PC.)											1.0	0.0010	1	

DESCRIPTION









 - NET WEIGHT

 VOLUME



 NUMBER OF PACKAGES

PRODUCT ILLUSTRATION	DIMENSIONS [mm]			INDEX SYMBOL						COMMENTS
	WIDTH	DEPTH	HEIGHT			kg	m3	pcs		

**SONIC - ACOUSTIC PANELS FOR SINGLE DESKS**

	1190	40	650	<b>ZPS612</b>		16.0	0.041	1		For 1200mm wide desks
	1390	40	650	<b>ZPS614</b>		17.0	0.048	1		For 1400mm wide desks
	1590	40	650	<b>ZPS616</b>		7.0	0.054	1		For 1600mm wide desks
	1790	40	650	<b>ZPS618</b>		20.0	0.063	2		For 1800mm wide desks
	1990	40	650	<b>ZPS620</b>		21.0	0.069	2		For 2000mm wide desks
	1190	40	800	<b>ZPS812</b>		14.0	0.050	1		For 1200mm wide desks only
	1390	40	800	<b>ZPS814</b>		15.0	0.058	1		For 1400mm wide desks only
	1590	40	800	<b>ZPS816</b>		16.0	0.066	1		For 1600mm wide desks only
	1790	40	800	<b>ZPS818</b>		9.6	0.075	1		For 1800mm wide desks only

**ADDITIONAL CHARGE**



FEATURE	PRODUCT													COMMENTS
	ZPS612	ZPS614	ZPS616	ZPS618	ZPS620	ZPS812	ZPS814	ZPS816	ZPS818		kg	m3	pcs	
II PRICE GROUP											0.0	0.0000	0	
III PRICE GROUP											1.0	0.0010	1	
HANGING RAIL (1 PC.)											1.0	0.0010	1	

DESCRIPTION

 - NET WEIGHT

 VOLUME

 NUMBER OF PACKAGES

PRODUCT ILLUSTRATION	DIMENSIONS [mm]			INDEX SYMBOL						COMMENTS
	WIDTH	DEPTH	HEIGHT			kg	m3	pcs		

SONIC - ACOUSTIC PANELS FOR SINGLE DESKS

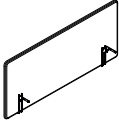
	1990	40	800	ZPS820		10.5	0.082	1		For 2000mm wide desks
---	------	----	-----	--------	--	------	-------	---	--	-----------------------

SONIC - ACOUSTIC PANELS FOR SINGLE DESK

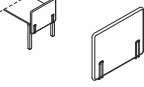
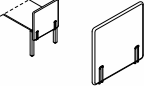
	800	40	650	ZUS30		7.5	0.027	1		
	800	40	800	ZUS50		8.0	0.033	1		

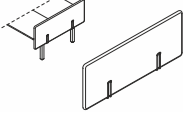
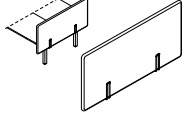

SONIC - ACOUSTIC PANELS FOR BENCH

	1600	40	650	ZUS31		11.0	0.053	1		
	1600	40	800	ZUS51		11.0	0.065	1		

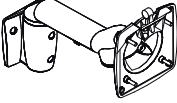
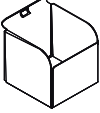
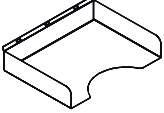
FUNCTION RAIL ACCESSORIES

	300	130	130	D1		3.0	0.012	1		PC holder, max monitor size 22" weight up to 7 kg, VESA FIXING, SPACING 100x100 and 75x75
	85	86	84	D2		0.5	0.001	1		organizer
	330	248	64	D3		1.0	0.006	1		shelf A-4

ADDITIONAL CHARGE



FEATURE	PRODUCT									COMMENTS
	ZPS820	ZUS30	ZUS50	ZUS31	ZUS51		kg	m3	pcs	
II PRICE GROUP							0.0	0.0000	0	
III PRICE GROUP							1.0	0.0010	1	
HANGING RAIL (1 PC.)							1.0	0.0010	1	

DESCRIPTION





 - NET WEIGHT

 VOLUME

 NUMBER OF PACKAGES

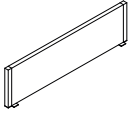
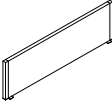
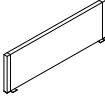
PRODUCT ILLUSTRATION	DIMENSIONS [mm]			INDEX SYMBOL						COMMENTS
	WIDTH	DEPTH	HEIGHT			kg	m3	pcs		

FABRIC PANELS BETWEEN TWO SINGLE DESKS - ERGONOMIC MASTER, ALFA



	1600	40	360	RE63		17.0	0.068	1		given height over desktop
	1400	40	360	RE64		15.5	0.059	1		height over the desktop
	1200	40	360	RE65		13.7	0.051	1		height over the desktop
	1000	40	360	RE66		12.0	0.042	1		height over the desktop
	800	40	360	RE67		9.5	0.034	1		height over the desktop
	600	40	360	RE68		7.7	0.026	1		height over the desktop

DESCRIPTION



 - NET WEIGHT

 VOLUME

 NUMBER OF PACKAGES

PRODUCT ILLUSTRATION	DIMENSIONS [mm]			INDEX SYMBOL						COMMENTS
	WIDTH	DEPTH	HEIGHT			kg	m3	pcs		

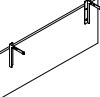
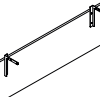
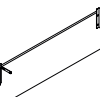
**MFC MODESTY PANELS**

	1000	18	400	<b>UM10</b>		7.0	0.013	2		for 1200mm wide desks only
	1200	18	400	<b>UM12</b>		8.0	0.015	2		for 1400mm wide desks only
	1400	18	400	<b>UM14</b>		9.0	0.017	2		for 1600mm wide desks only
	1600	18	400	<b>UM16</b>		10.0	0.019	2		for 1800mm wide desks only
	1800	18	400	<b>UM18</b>		11.0	0.021	2		for 2000mm wide desks only

**METAL MODESTY PANELS**

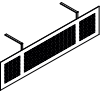
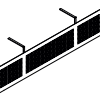
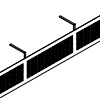
	1200	15	300	<b>UR14</b>		2.8	0.008	1		for 1400mm wide desks, not suitable for YAN
	1400	15	300	<b>UR15</b>		3.1	0.009	1		for 1600mm wide desks, not suitable for YAN
	1600	15	300	<b>UR16</b>		3.5	0.010	1		for 1800mm wide desks, not suitable for YAN

DESCRIPTION

 - NET WEIGHT

 VOLUME

 NUMBER OF PACKAGES